

Majestic Pure Selection

4 COLOURS

3 SIZES

2 SURFACES

The allure and elegance of Italian white marble is reproduced on the ceramic surfaces of Majestic Pure Selection.

Il fascino e l'eleganza del candore
marmoreo italiano rivivono sulle
superfici ceramiche di Majestic Pure
Selection.

Der Charme und die Eleganz
des reinweißen italienischen
Marmors erwecken sich auf den
Keramikoberflächen von Majestic
Pure Selection.

Le charme et l'élégance de la
blancheur éclatante du marbre
italien reprennent vie sur les surfaces
céramiques de Majestic Pure
Selection.

Majestic Pure Selection



Spazi Residenziali
Residential Spaces

P. 5

Spazi Pubblici
Public Areas

P. 25

Informazioni Tecniche
Technical Information

P. 39



La speciale selezione di pregiati marmi Majestic in cui tutta la purezza del bianco viene esaltata dalle quattro trame nobili delle venature italiane più belle e ricercate, come Calacatta, Statuario, Arabescato e Dolomiti.

The special selection of fine Majestic marbles in which all the purity of white is enhanced by the four elegant patterns of the most beautiful and sought-after Italian veining, Calacatta, Statuario, Arabescato and Dolomiti.

Die Reinheit der Weißtöne wird durch edle Zeichnung der vier schönsten und begehrtesten italienischen Marmore wie Calacatta, Statuario, Arabescato und Dolomiti betont.

Dans cette sélection spéciale de marbres précieux Majestic, toute la pureté du blanc est exaltée par les quatre lacs de nobles veinages italiens parmi les plus beaux et les plus recherchés : Calacatta, Statuario, Arabescato et Dolomiti.

Residential Spaces
& Public Areas

Spazi Residenziali

Residential Spaces
Wohnanlagen
Espaces Résidentiels



COLORI / COLOURS

AMBIENTI / AMBIENT

PAGINA / PAGE

Magnificent Calacatta

Living

6

Magnificent Calacatta

Kitchen

8

Superb Statuario

Bathroom

12

Superb Statuario

Bedroom

18

Sublime Dolomiti

Bathroom

21

Majestic Pure Selection
Residential Spaces

5

Magnificent Calacatta

60×119,5 - 24"×47½" Magnificent Calacatta Levigato Rettificato
119,5×119,5 - 47½"×47½" Magnificent Calacatta Levigato Rettificato



Very high-resolution digital printing technology makes the surfaces of Majestic Pure Selection aesthetically unrivalled, both in the natural version and in the fully polished version, in which the material's brightness and depth are enhanced by a fine and attractive ultra-glossy effect.

Die hochauflösende Digitaldrucktechnik bewirkt ein unvergleichlich ästhetisches Erscheinungsbild der Oberflächen von Majestic Pure Selection. Dies gilt sowohl für die natürliche als auch für die spiegelglanzpolierte Version, wo der Glanz und die Tiefe der Materie wird durch einen ultragläänzenden und fesselnd Effekt vermehrt.

La technologie d'impression numérique à très haute résolution rend les surfaces de Majestic Pure Selection esthétiquement incomparables, tant dans la version naturelle que dans la version polie miroir, dans laquelle la brillance et la profondeur du matériau sont rehaussées par un effet ultra-brillant fin et séduisant.

La tecnologia di stampa digitale ad altissima risoluzione, rende le superfici di Majestic Pure Selection esteticamente impareggiabili, sia nella versione naturale che in quella levigata a specchio, in cui la lucentezza e la profondità della materia vengono esaltate da un effetto ultra glossy fine ed accattivante.



Magnificent Calacatta

60x119,5 - 24"x47 1/8" Magnificent Calacatta Naturale Rettificato



60x119,5 - 24"x47 1/8" Foliage Naturale Rettificato





Superb Statuario

Grove's stylized leaf design has a unique appeal that enhances the look of a room with a rhapsodic graphic effect that is never mundane. The abstract interpretation of plant elements gives the room a modern and structured look and is perfect for decorating walls in sophisticated contemporary contexts.

Das Design der stilisierten Blätter von Grove schenkt einen einzigartigen Appeal und trägt seine besondere Ausstrahlung dazu bei, den Look des Ambientes durch die Aufwertung von einer rhapsodischen und nie trivialen Grafik. Die abstrakte Interpretation der pflanzlichen Elemente verleiht dem Raum einen aktuellen, strukturierten Look und ist perfekt für Wanddekorationen in modernen, erlesenen Raumwelten.

Le motif de feuilles stylisées de Grove lui confère un attrait unique et contribue à sublimer le look de la pièce, mise en valeur par un graphisme au trait rhapsodique et jamais banal. Donnant à la pièce un caractère moderne et structuré, l'interprétation abstraite des éléments végétaux est parfaite pour décorer les murs de cadres contemporains et sophistiqués.

Il design delle foglie stilizzate di Grove regala un appeal unico e contribuisce ad elevare il look dell'ambiente valorizzandolo con un tratto grafico rapsodico e mai banale. L'interpretazione in chiave astratta degli elementi vegetali conferisce all'ambiente un'attitudine moderna e strutturata, ed è perfetta per decorare le pareti in contesti attuali e sofisticati.

60x119,5 - 24"x47½" Grove Levigato Rettificato



Superb Statuario

30x30 - 12"x12" Mosaico Superb Statuario Naturale Rettificato



60x60 - 24"x24" Super Statuario Naturale Rettificato



Majestic Pure Selection Residential Spaces



Sublime Dolomiti

Majestic Pure Selection marbles, evoking living contexts with an aristocratic feel, as well as contemporary spaces with eclectic touches featuring a balanced mix of classic and modern style, eccentricity and finesse.

Die Marmoroptiken von Majestic Pure Selection bieten sich für aristokratisch anmutende, aber auch moderne Wohnkonzepte an und sorgen für ungewohnte Akzente durch einen ausgewogenen Mix aus klassischem und modernem Stil, Extravaganz und Finesse.

Les marbres Majestic Pure Selection évoquent des cadres de vie au cachet aristocratique, mais aussi des espaces plus contemporains, aux accents éclectiques caractérisés par un mélange équilibré de style classique et moderne, d'excentricité et de finesse.

I marmi Majestic Pure Selection, suggeriscono contesti abitativi dal sapore aristocratico, ma anche spazi più contemporanei, con accenti eclettici caratterizzati da un mix equilibrato tra stile classico e moderno, eccentricità e finezza.

60x119,5 - 24"x47½" Sublime Dolomiti Levigato Rettificato

30x30 - 12"x12" Mosaico Sublime Dolomiti Levigato Rettificato
Vanity Top Sublime Dolomiti 80x50x15 - 32"x20"x6"



Majestic Pure Selection
Residential Spaces

Sublime Dolomiti

30x30 - 12"x12" Mosaico Sublime Dolomiti Levigato Rettificato
Vanity Top Sublime Dolomiti 80x50x15 - 32"x20"x6"



60x119,5 - 24"x47 1/2" Sublime Dolomiti Levigato Rettificato



Spazi Pubblici

Public Areas
Öffentliche Räumlichkeiten
Espaces Publics



60x119,5 - 24"x47½" Glorious Arabescato Naturale Rettificato
Vanity Top Glorious Arabescato 119x50x5 - 47"x20"x2"

COLORI / COLOURS

AMBIENTI / AMBIENT

PAGINA / PAGE

Glorious Arabescato

Suite Hotel

26

Sublime Dolomiti

Beauty Store

30

Superb Statuario

Bathroom

34

Majestic Pure Selection
Public Areas

25

Glorious Arabescato

30x30 - 12"x12" Mosaico Glorious Arabescato Levigato Rettificato
Lavabo Waterfall Majestic Royal Nero 100x50x15 - 40"x20"x6"

60x119,5 - 24"x47 1/8" Foliage Naturale Rettificato

119,5x119,5 - 47 1/8"x47 1/8" Glorious Arabescato Levigato Rettificato



Glorious Arabescato

30x30 - 12"x12" Mosaico Glorious Arabescato Levigato Rettificato
60x119,5 - 24"x47½" Foliage Naturale Rettificato



With Foliage, nature inspires interior design with decorative elements and imaginative colour selections, lending character, freshness and an eclectic touch to the walls. With its fresh and elegant style, Foliage is a furnishing element that can be played with to transform spaces into lush living jungles.

Mit Foliage hält die Natur Einzug in das Raumdesign. Dekorative Elemente und phantasievolle Farbpaletten verleihen Wänden Charakter, Frische und einen eklektischen Touch. Die Dekoration Foliage wird mit ihrem erfrischenden und doch eleganten Stil zu einem Gestaltungselement, mit dem sich Räume spielerisch in eine grüne Oase verwandeln lassen.

Avec Foliage, la décoration intérieure puise son inspiration dans la nature : des éléments décoratifs et des palettes de couleurs empreintes de fantaisie confèrent aux murs caractère, fraîcheur et une pointe d'éclectisme. Foliage offre son style à la fois frais et élégant comme un élément de décoration ludique, transformant les espaces en luxuriantes jungles à habiter.

Con Foliage la natura ispira l'interior design regalando elementi decorativi e palette cromatiche fantasiose, capaci di donare carattere, freschezza ed un tocco eclettico alle pareti. Foliage con il suo stile fresco ed elegante al tempo stesso si offre come elemento d'arredo per giocare trasformando gli spazi in lussureggianti giungle da vivere.

Sublime Dolomiti

60x119,5 - 24"x47½" Sublime Dolomiti Naturale Rettificato
119,5x119,5 - 47½"x47½" Sublime Dolomiti Levigato Rettificato



30x30 - 12"x12" Mosaico Sublime Dolomiti Levigato Rettificato

Vanity Top Sublime Dolomiti 119x50x5 - 47"x20"x2"
Vanity Top Majestic Supreme Grey 119x50x15 - 47"x20"x6"



Sublime Dolomiti

Majestic Pure Selection offers an elegant selection of colours that allow you to indulge in the beauty of these habitats through a dialogue created to pay homage to Italian white marble and its eternal beauty, in keeping with Ceramiche Piemme's sophisticated style.

Die elegante Palette von Majestic Pure Selection ermöglicht es, der Schönheit dieser Lebensräume in einem Dialog nachzukommen, der eine Hommage an den weißen italienischen Marmor und seine zeitlose Schönheit durch den raffinierten Stil von Ceramiche Piemme sein soll.

À travers un dialogue instauré pour rendre hommage au marbre blanc italien et à sa beauté éternelle, l'élégante palette de Majestic Pure Selection permet de magnifier la beauté de ces lieux de vie dans un style sophistiqué signé Ceramiche Piemme.

La palette elegante di Majestic Pure Selection permette di assecondare la bellezza degli spazi, attraverso un dialogo creato per rendere omaggio al marmo bianco italiano ed alla sua eterna bellezza, secondo uno stile sofisticato firmato Ceramiche Piemme.

119,5×119,5 - 47½"×47½" Sublime Dolomiti Levigato Rettificato

60×119,5 - 24"×47½" Sublime Dolomiti Naturale Rettificato
Vanity Top Majestic Supreme Grey 119×50×15 - 47"×20"×6"



Superb Statuario

30x30 - 12"x12" Mosaico Superb Statuario Levigato Rettificato
60x119,5 - 24"x47 1/8" Grove Levigato Rettificato



60x119,5 - 24"x47 1/8" Superb Statuario Levigato Rettificato

Lavabo a colonna Superb Statuario 50x50x85 - 20"x20"x34"
Vanity Top Superb Statuario 119x50x10 - 47"x20"x4"



Superb Statuario

The furnishing elements of the Piemme Project Solution, such as shower trays and vanity tops, help to create perfectly coordinated environments, further enhanced by decorative elements that can be matched to each marble such as mosaic tiles, which are handcrafted and always ready to shine on small and large walls with their glamorous, refined touch.

Die Einrichtungselemente des Projekts Piemme Project Solution wie Duschwannen und Waschtischplatten tragen zur Schaffung stimmiger Räume bei. Passend zu den einzelnen Marmoroptiken, sorgen Dekorationen, wie das handwerklich gefertigte klassische Mosaik, das großen wie kleinen Wänden einen Glamour-Touch verleiht, zusätzlich für eine stilistische Aufwertung des Raumkonzepts.

Receveurs de douche, plans de toilette, ces éléments d'ameublement de Piemme contribuent à la création d'espaces parfaitement coordonnés, que viennent enrichir des décorations associées à chaque marbre : fabriquée de façon artisanale, toujours prête à briller sur des pans de murs ou des murs entiers, la mosaïque à tesselles apporte son accent glamour et raffiné.

Gli elementi d'arredo del progetto Piemme Project Solution, come piatti doccia e vanity top contribuiscono alla creazione di ambienti perfettamente coordinati, ulteriormente impreziositi dagli elementi decorativi abbinabili per ciascuna essenza marmorea come il mosaico a tessere, realizzato artigianalmente e sempre pronto a risplendere su piccole e grandi pareti con il suo tocco glam e raffinato.

60x119,5 - 24"x47½" Superb Statuario Levigato Rettificato

30x30 - 12"x12" Mosaico Superb Statuario Levigato Rettificato
Vanity Top Superb Statuario 119x50x10 - 47"x20"x4"



Informazioni Tecniche

4

Colori
Colours
Farben
Couleurs



3

Formati
Sizes
Formate
Formats

119,5×119,5 47½"×47½"	60×119,5 24"×47½"	60×60 24"×24"

2

Spessori
Thickness
Stärke
Epaisseur

±9 ±9,5

2

Superfici
Surfaces
Oberflächen
Surfaces

Naturale Levigato

i

Effetto Marmo
Marble Look
Marmoroptik
Effet Marbre

Rivestimento
Wall Tiles
Wandfliesen
Revêtement

Pavimento
Floor Tiles
Bodenfliesen
Sol

Gres fine porcellanato ad impasto colorato
Coloured-body fine porcelain stoneware
Feinsteinzeug aus farbiger Masse
Grès cérame fin à pâte colorée

Tecnologia digitale
Digital technology
Digital technologie
Technologie numérique



Superb Statuario

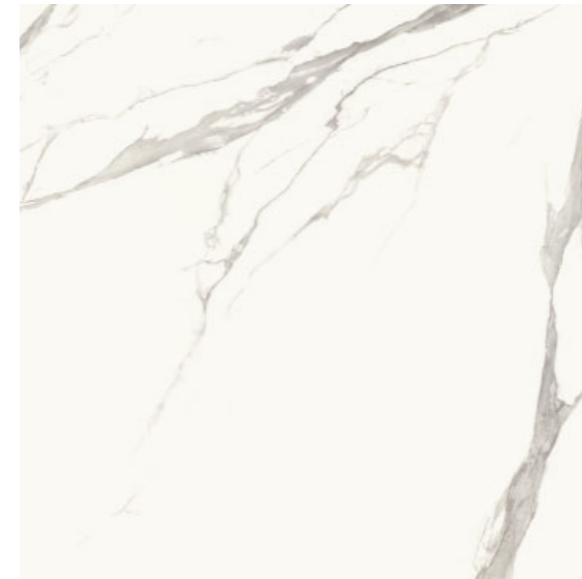

± 9

119,5×119,5 - 47½"×47½"
03921 | Superb Statuario Lev/Ret



± 9,5

60×119,5 - 24"×47½"
03908 | Grove Lev/Ret
(mix 6 graphics)



± 9,5

60×119,5 - 24"×47½"
03909 | Foliage Nat/Ret
(mix 6 graphics)



± 9,5

60×119,5 - 24"×47½"
03901 | Superb Statuario Nat/Ret
03905 | Superb Statuario Lev/Ret



30×30 - 12"×12"

03926 | Mosaico Superb Statuario Nat/Ret
03931 | Mosaico Superb Statuario Lev/Ret

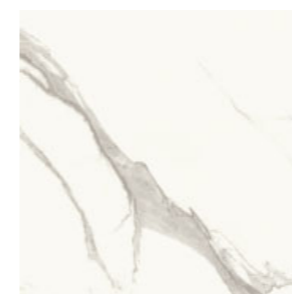

± 9,5

60×60 - 24"×24"
03912 | Superb Statuario Nat/Ret
03916 | Superb Statuario Lev/Ret

Pezzi speciali
Special pieces



Battiscopa 4,5×60 ± 9,5

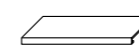

Gradino Costa Retta 33×119,5 ± 9,5

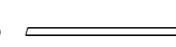

Bacchetta Jolly 1,5×119,5 ± 9,5

Unghia Jolly 1,5×1,5 ± 9,5



Glorious Arabescato



± 9

119,5×119,5 - 47½"×47½"

03922 | Glorious Arabescato Lev/Ret



± 9,5

60×119,5 - 24"×47½"

03908 | Grove Lev/Ret
(mix 6 graphics)



± 9,5

60×119,5 - 24"×47½"

03909 | Foliage Nat/Ret
(mix 6 graphics)



± 9,5

60×119,5 - 24"×47½"

03902 | Glorious Arabescato Nat/Ret
03906 | Glorious Arabescato Lev/Ret



30×30 - 12"×12"

03927 | Mosaico Glorious Arabescato Nat/Ret
03932 | Mosaico Glorious Arabescato Lev/Ret



± 9,5

60×60 - 24"×24"

03913 | Glorious Arabescato Nat/Ret
03917 | Glorious Arabescato Lev/Ret

Pezzi speciali
Special pieces



Battiscopa 4,5×60 ± 9,5

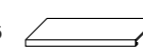

Gradino Costa Retta 33×119,5 ± 9,5

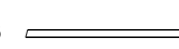

Bacchetta Jolly 1,5×119,5 ± 9,5

↳ Unghia Jolly 1,5×1,5 ± 9,5

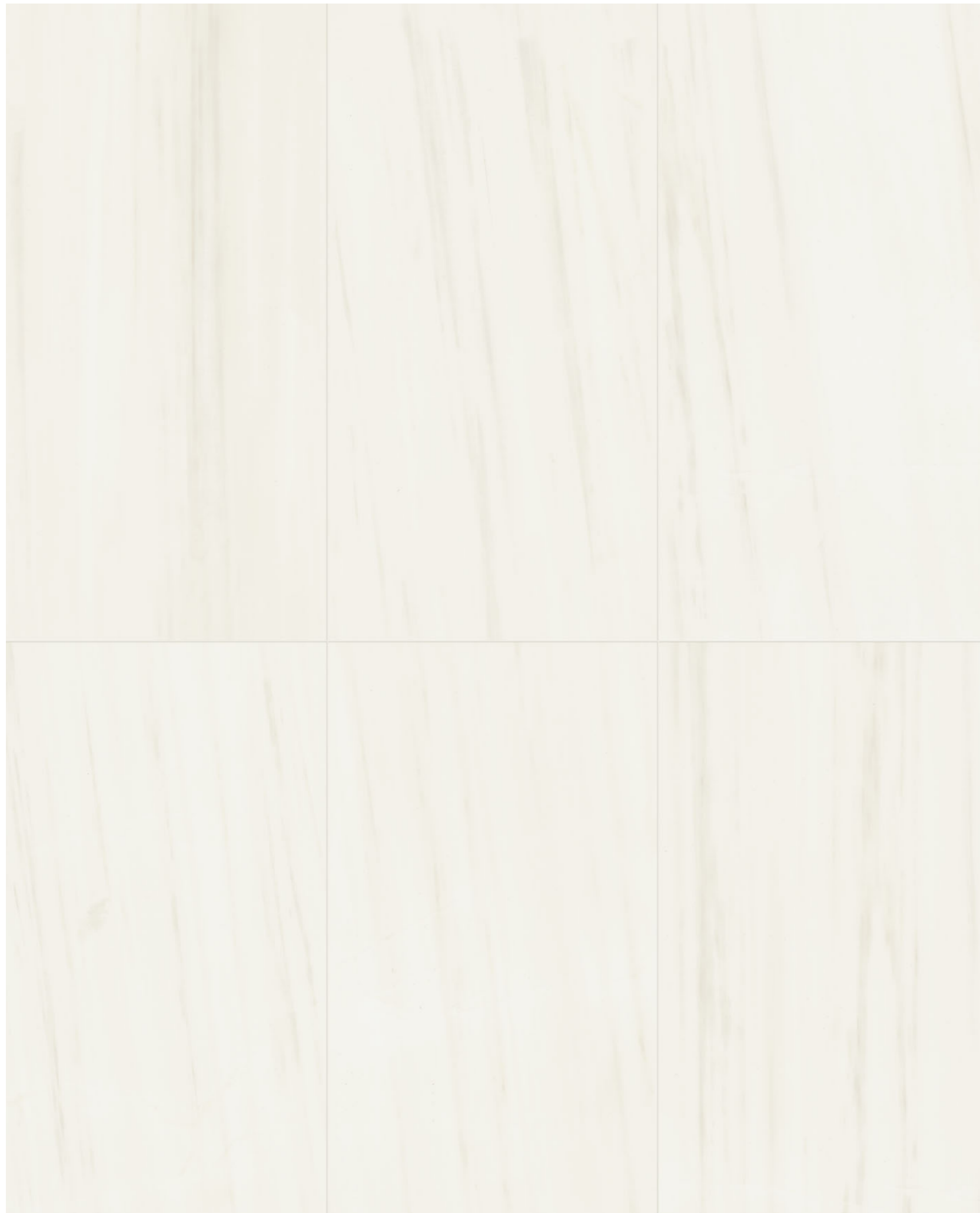

Sublime Dolomiti

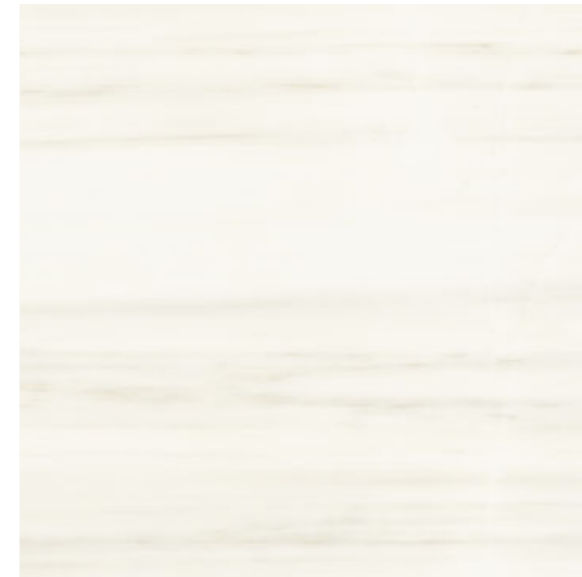

± 9

119,5x119,5 - 47½"x47½"

03923 | Sublime Dolomiti Lev/Ret



± 9,5

60x119,5 - 24"x47½"

03908 | Grove Lev/Ret
(mix 6 graphics)



± 9,5

60x119,5 - 24"x47½"

03909 | Foliage Nat/Ret
(mix 6 graphics)



± 9,5

60x119,5 - 24"x47½"

03903 | Sublime Dolomiti Nat/Ret
03907 | Sublime Dolomiti Lev/Ret



30x30 - 12"x12"

03928 | Mosaico Sublime Dolomiti Nat/Ret
03933 | Mosaico Sublime Dolomiti Lev/Ret



± 9,5

60x60 - 24"x24"

03914 | Sublime Dolomiti Nat/Ret
03918 | Sublime Dolomiti Lev/Ret

Pezzi speciali
Special pieces



Battiscopa 4,5x60 ± 9,5

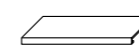

Gradino Costa Retta 33x119,5 ± 9,5

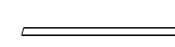

Bacchetta Jolly 1,5x119,5 ± 9,5

↳ Unghia Jolly 1,5x1,5 ± 9,5



Magnificent Calacatta



119,5×119,5 - 47½"×47½"
03919 | Magnificent Calacatta Lev/Ret



60×119,5 - 24"×47½"
03908 | Grove Lev/Ret
(mix 6 graphics)



60×119,5 - 24"×47½"
03909 | Foliage Nat/Ret
(mix 6 graphics)



60×119,5 - 24"×47½"
03899 | Magnificent Calacatta Nat/Ret
03904 | Magnificent Calacatta Lev/Ret





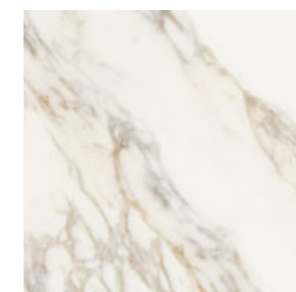





30×30 - 12"×12"
03925 | Mosaico Magnificent Calacatta Nat/Ret
03929 | Mosaico Magnificent Calacatta Lev/Ret



60×60 - 24"×24"
03911 | Magnificent Calacatta Nat/Ret
03915 | Magnificent Calacatta Lev/Ret



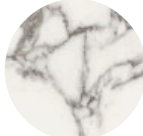



Riepilogo Gamma

Collection
Serie
Gamme

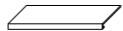
											
		119,5x119,5 - 47¼"x47¼"	60x119,5 - 24"x47¼"	60x60 - 24"x24"		Din 51130	Din 51097	Dcof	Grove 60x119,5 - 24"x47¼"	Foliage 60x119,5 - 24"x47¼"	Mosaico 30x30 - 12"x12"
		± 9	± 9,5	± 9,5					± 9,5	± 9,5	± 9,5
 Superb Statuario	Nat/Ret		03901	03912	V2	R9	A	>0.42		03909	03926
	Lev/Ret	03921	03905	03916						03908	
 Glorious Arabescato	Nat/Ret		03902	03913	V2	R9	A	>0.42		03909	03927
	Lev/Ret	03922	03906	03917						03908	
 Sublime Dolomiti	Nat/Ret		03903	03914	V2	R9	A	>0.42		03909	03928
	Lev/Ret	03923	03907	03918						03908	
 Magnificent Calacatta	Nat/Ret		03899	03911	V2	R9	A	>0.42		03909	03925
	Lev/Ret	03919	03904	03915						03908	

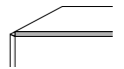
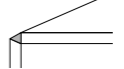





Riepilogo Gamma

Collection
Serie
Gamme

		Pezzi Speciali Special Pieces			
					
		Gradino Costa Retta 33x119,5 - 13"x47¼"	Battiscopa 4,5x60 - 1¾"x24"	Bacchetta Jolly 1,5x119,5 - ¾"x47¼"	Unghia Jolly 1,5x1,5 - ¾"x¾"
		± 9,5	± 9,5	± 9,5	± 9,5
 Superb Statuario	Nat/Ret	03948	03939		
	Lev/Ret	03944	03935	03952	03956
 Glorious Arabescato	Nat/Ret	03949	03941		
	Lev/Ret	03945	03936	03953	03957
 Sublime Dolomiti	Nat/Ret	03950	03942		
	Lev/Ret	03946	03937	03954	03958
 Magnificent Calacatta	Nat/Ret	03947	03938		
	Lev/Ret	03943	03934	03951	03955

Imballi

Packing
Verpackung
Emballage

Formati Sizes		± MM	 Pezzi Scatola Pieces/Box Stck/Karton Carreaux/Boîte	 Mq/Scatola Sqmt/Box Qm/Karton M2/Boîte	 Kg/Scatola Kgs/Box Kg/Karton Kg/Boîte	 Scatole/Paletta Boxes/Pallet Karton/Palette Boîte/Palette	 Mq/Paletta Sqmt/Pallet Qm/Pallet M2/Palette	 Kg/Paletta Kgs/Pallet Kg/Pallet Kg/Palette	 Formato Paletta Size Pallet Format Pallet Dim. Palette
119,5x119,5 (47½"×47½") Lev/Ret	P	9	2	2,86	55,50	22	62,92	1221	132x132x53
60x119,5 (24"×47½") Nat/Ret	P	9,5	2	1,434	31,00	30	43,02	930	120x80x75
60x119,5 (24"×47½") Lev/Ret	P	9,5	2	1,434	32,00	30	43,02	960	120x80x75
60x60 (24"×24") Nat/Ret	P	9,5	3	1,080	21,50	40	43,20	860	120x80x75
60x60 (24"×24") Lev/Ret	P	9,5	3	1,080	22,50	40	43,20	900	120x80x75
60x119,5 (24"×47½") Foliage Nat/Ret	P	9,5	2	1,434	31,00	30	43,02	930	120x80x75
60x119,5 (24"×47½") Grove Lev/Ret	P	9,5	2	1,434	32,00	30	43,02	960	120x80x75
30x30 (12"×12") Mosaico Nat/Ret	P	9,5	5	0,450	8,00	60	-	-	-
30x30 (12"×12") Mosaico Lev/Ret	P	9,5	5	0,450	8,00	60	-	-	-
Pezzi Speciali / Special Pieces									
33x119,5 (13"×47½") Gradino Costa Retta Nat/Ret - Lev/Ret	P	9,5	2	0,789	18,50	20	-	-	-
4,5x60 (1¾"×24") Battiscopa Nat/Ret - Lev/Ret	P	9,5	14	0,378 m.l. 8,40	8,00	80	-	-	-
1,5x119,5 (¾"×47½") Bacchetta Jolly Lev/Ret	P	9,5	6	0,108	2,50	48	-	-	-
1,5x1,5 (¾"×¾") Unghia Jolly Lev/Ret	P	9,5	6	0,001	0,50	48	-	-	-

Pezzi Speciali

Special pieces
Formstücke
Pièces spéciales

Battiscopa Nat/Ret 4,5x60 – 1¾"×24" ± 9,5
Battiscopa Lev/Ret 4,5x60 – 1¾"×24" ± 9,5

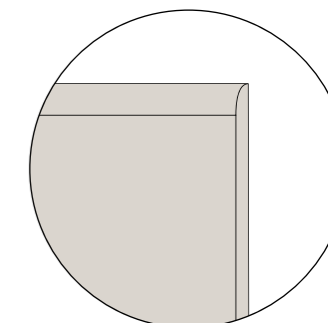

Gradino Costa Retta Nat/Ret 33x119,5 – 13"×47½" ± 9,5
Gradino Costa Retta Lev/Ret 33x119,5 – 13"×47½" ± 9,5
(costa retta ottenuto per taglio e incollaggio - obtained by cutting and gluing)

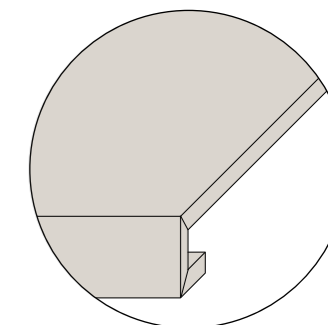
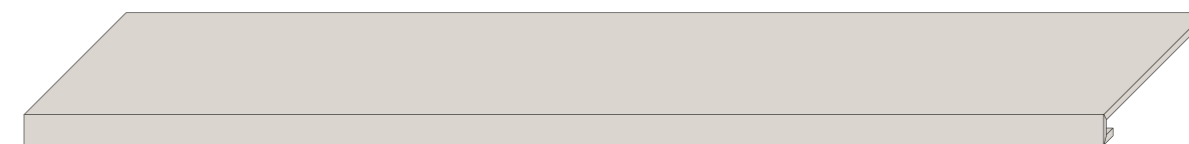

Pezzi Speciali

Special pieces
Formstücke
Pièces spéciales

Bacchetta Jolly Lev/Ret 1,5x119,5 - 5/8"x47 1/8" ± 9,5

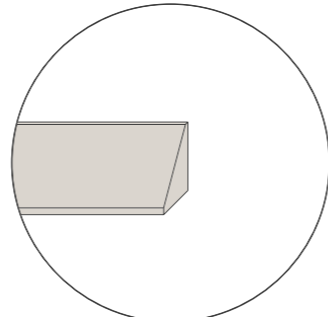
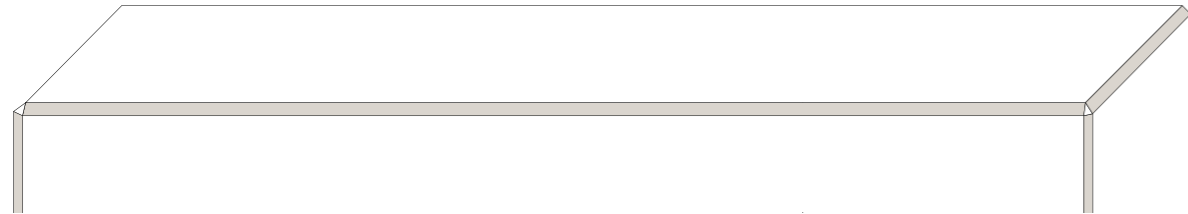

Unghia Jolly Lev/Ret 1,5x1,5 - 5/8"x5/8" ± 9,5

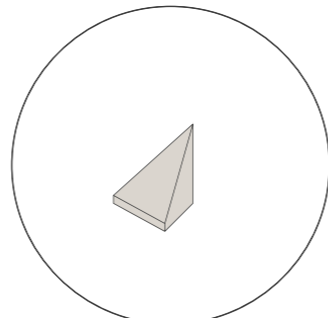

Elementi di Raccordo Bacchetta e Unghia Jolly

Universal Bevel Filler Strip and Corner Filler Chip
Verbindungselemente Universalleiste und -aussenecke
Éléments de raccord baguette et onglet Jolly



Angoli Muretti / Wall Bevel Corners /
Ecke für Zwischenwände / Angles murets



Spigoli Scale / Staircase Bevel Edge /
Kanten für Treppen / Arêtes escaliers

Caratteristiche Tecniche

Technical characteristics
Technische daten
Caracteristiques techniques

CLASSIFICAZIONE SECONDO NORME EN 14411 BI_A - ISO 13006 - CLASSIFICATION IN ACCORDANCE WITH EN 14411 BI_A - ISO 13006
KLASSIFIZIERUNG GEMÄSS NORMEN EN 14411 BI_A - ISO 13006 - CLASSIFICATION SELON LES NORMES EN 14411 BI_A - ISO 13006

CARATTERISTICA TECNICA TECHNICAL CHARACTERISTIC TECHNISCHE DATE CARACTÉRISTIQUE TECHNIQUE	NORMA NORM NORM NORME	VALORE PRESCRITTO VALUE REQUIRED NORMVORGABE VALEUR PRESCRITE	VALORE MEDIO MEAN VALUE MITTELWERT VALEUR MOYENNE CERAMICHE PIEMME, FLOOR AND MORE	NORMA NORM NORM NORME	VALORE MEDIO MEAN VALUE MITTELWERT VALEUR MOYENNE CERAMICHE PIEMME, FLOOR AND MORE
LUNGHEZZA E LARGHEZZA LENGHT AND WIDTH / LÄNGE UND BREITE / LONGUEUR ET LARGEUR		±0.6% (±2.00 MM)			
SPESSORE THICKNESS / STÄRKE / ÉPAISSEUR		±5% (±0.5 MM)			
RETTILINEITÀ LATI WARPAGES OF EDGES / GERADHEIT DER KANTEN / RÉCTITUDE DES ARÊTES	ISO 10545.2	±0.5% (±1.5 MM)	CONFORME IN ACCORDANCE ERFÜLLT CONFORME	ASTM C-499 ASTM C-485 ASTM C-502	IN ACCORDANCE
ORTOGONALITÀ WEDGING / RECHTWINKLIGKEIT / ORTHOGONALITÉ		±0.5% (±2.00 MM)			
PLANARITÀ FLATNESS / PLANITÄT / PLANIMÉTRIE		±0.5% (±2.00 MM)			
ASSORBIMENTO % D'ACQUA WATER ABSORPTION WASSERANNAHME % ABSORPTION D'EAU %	ISO 10545.3	≤ 0.5%	CONFORME IN ACCORDANCE ERFÜLLT CONFORME	ASTM C-373	IN ACCORDANCE
RESISTENZA ALLA FLESSIONE BENDING STRENGTH BIEGEZUGFESTIGKEIT RÉSISTANCE À LA FLEXION	ISO 10545.4	MODULUS OF RUPTURE (AVERAGE): R ≥ 35N/MM ² BREAKING STRENGTH FOR THICKNESS ≥ 7.5 MM: S > 1300 N	CONFORME IN ACCORDANCE ERFÜLLT CONFORME	ASTM C-648 250 LBS OR GREATER	IN ACCORDANCE
DILATAZIONE TERMICA LINEARE TRA 20° E 100° C LINEAR THERMAL EXPANSION BETWEEN 20° AND 100° C LINEARE WÄRMEAUSENDENUNG ZWISCHEN 20° UND 100° C DILATATION THERMIQUE LINEAIRE ENTRE 20° ET 100° C	ISO 10545.8	SECONDO I DATI DEL COSTRUTTORE ACCORDING TO BUILDER'S SPECIFICATIONS LAUT ANGABEN DES HERSTELLERS SELON LES ELEMENTS DU COSTRUCTEUR	≈ 7X10 ⁻⁶ C ⁻¹		
RESISTENZA AGLI SBALZI TERMICI THERMAL SHOCK RESISTANCE TEMPERATURWECHSELBESTÄNDIGKEIT RÉSISTANCE AUX ÉCARTS DE TEMPÉRATURE	ISO 10545.9	RICHIESTA REQUEST BITTE DEMANDE	RESISTENTE RESISTANT WIDERSTEHEND RÉSISTANT		
RESISTENZA AL GELO FROST RESISTANCE FROSTBESTÄNDIGKEIT RÉSISTANCE AU GEL	ISO 10545.12	RICHIESTA REQUEST BITTE DEMANDE	RESISTENTE RESISTANT WIDERSTEHEND RÉSISTANT	ASTM C-1026	IN ACCORDANCE
RESISTENZA ALL'ATTACCO CHIMICO RESISTANCE TO CHEMICAL ATTACK BESTÄNDIGKEIT GEGEN CHEMIKALIEN RÉSISTANCE À L'ATTAQUE CHIMIQUE	ISO 10545.13	SECONDO I DATI DEL COSTRUTTORE ACCORDING TO BUILDER'S SPECIFICATIONS LAUT ANGABEN DES HERSTELLERS SELON LES ELEMENTS DU COSTRUCTEUR	RESISTENTE RESISTANT WIDERSTEHEND RÉSISTANT	ASTM C-650	IN ACCORDANCE
RESISTENZA DEI COLORI ALLA LUCE COLOURS RESISTANCE TO LIGHT LICHTBESTÄNDIGKEIT RÉSISTANCE DES COULEURS À LA LUMIÈRE	DIN 51094	NESSUNA ALTERAZIONE NO ALTERATION KEINE VERÄNDERUNG AUCUNE ALTERATION	CONFORME IN ACCORDANCE ERFÜLLT CONFORME		
RESISTENZA ALLE MACCHIE STAIN RESISTANCE FLECKENFESTIGKEIT RÉSISTANCE AUX TACHES	ISO 10545.14	≥ CLASSE 3 METODO DI PROVA DISPONIBILE TEST METHOD AVAILABLE VERFÜGBARE PRÜFMETHODE METHODE D'ESSAI DISPONIBILE	CONFORME IN ACCORDANCE ERFÜLLT CONFORME		
RESISTENZA ALLO SCIVOLAMENTO SLIP/PADE RESISTANCE RUTSCHSICHERHEIT RÉSISTANCE AU GLISSEMENT	DIN 51130 *	9 ≤ R ≤ 13	NAT LEV	R9 ASTM C-1028 * COF ≥ 0.6 DRY ≥ 0.6 WET	NAT LEV
	DIN 51097 *	A,B,C	NAT LEV	A ANSI * 1371-2012 DCOF > 0.42 WET	NAT LEV
PENDULUM SLIP TEST	BS EN 7976-2*	> 36 DRY > 36 WET	NAT LEV	AS 4586: 2013 CLASS	NAT LEV

*TRATTANDOSI DI NORMATIVE NAZIONALI, I METODI DI PROVA, I REQUISITI E LE CLASSIFICAZIONI VARIANO DA PAESE A PAESE. IL VALORE ATTESO DALLA RESISTENZA ALLO SCIVOLAMENTO DELLA PRODUZIONE DI INDUSTRIE CERAMICHE PIEMME S.P.A., PUÒ VARIARE IN BASE AL LOTTO PRODUTTIVO. SPECIFICA DOCUMENTAZIONE È DISPONIBILE SU RICHIESTA.
TEST METHODS, REQUIREMENTS AND CLASSIFICATIONS DIFFER FROM COUNTRY TO COUNTRY, ACCORDING TO THE NATIONAL REGULATIONS. THE EXPECTED VALUE OF SLIPPAGE RESISTANCE OF PRODUCTS BY INDUSTRIE CERAMICHE PIEMME S.P.A. MAY VARY DEPENDING ON THE PRODUCTION BATCH. SPECIFIC DOCUMENTS ARE AVAILABLE UPON REQUEST.
PRÜFVERFAHREN, ERFORDERNISSE UND KLASSIFIKATIONEN SIND VERSCHIEDEN VON LAND ZU LAND, GEMÄSS DER NATIONALEN VORSCHRIFTEN. DER ERWARTUNGSWERT DER RUTSCHSICHERHEIT DER PRODUKTE VON INDUSTRIE CERAMICHE PIEMME S.P.A. KANN SICH - JE NACH DER PRODUKTIONSPARTIE - VERÄNDERN. SPEZIFISCHE UNTERLAGEN SIND AUF VERLANGEN ZUR VERFÜGUNG.
LES MÉTHODES D'ESSAI, LES RÉQUISITIONS ET LES CLASSIFICATIONS CHANGENT DE PAYS À PAYS, SELON LES RÉGLEMENTATIONS NATIONALES. LA VALEUR ATTENDUE DE RÉSISTANCE AU GLISSEMENT DES PRODUITS DE INDUSTRIE CERAMICHE PIEMME S.P.A. PEUT VARIER EN FONCTION DU LOT DE PRODUCTION. UNE DOCUMENTATION SPÉCIFIQUE EST DISPONIBLE SUR DEMANDE.

ELENCO DELLE SERIE CERTIFICATE E CLASSIFICAZIONI DISPONIBILI A RICHIESTA - LIST OF CERTIFIED SERIES AND CLASSIFICATIONS AVAILABLE UPON REQUEST
LISTE DER GEPRÜFTEN SERIE UND KLASSIFIZIERUNGEN AUF ANFRAGE ERHÄLTICH - LISTE DES SERIES CERTIFIÉES ET DES CLASSEMENTS DISPONIBLES SUR DEMANDE



CERAMICHE PIEMME
FLOOR AND MORE



Norme per la posa e la manutenzione

Installation and maintenance instructions

Verlegung, reiningung und pflege

Guide a la pose et l'entretien

- Per i prodotti rettificati consigliamo una fuga di 2 mm per un migliore risultato di posa.

- Per una migliore resa estetica Piemme consiglia stuccature colorate in tinta con le piastrelle. Verificare, prima dell'utilizzo, la compatibilità ed idoneità dei riempitivi per fughe con il prodotto ceramico.

- Rimuovere le eccedenze dei riempitivi per fughe quando gli stessi sono ancora freschi.

- Attenersi scrupolosamente alle istruzioni indicate dai produttori dei riempitivi per fughe.

- Per eliminare completamente i residui di posa, che potrebbero compromettere la manutenzione ordinaria e le caratteristiche del prodotto, a posa ultimata, procedere con la pulizia utilizzando prodotti adeguati, a base Acida max 3%, rispettando le indicazioni del produttore. Osservare assolutamente i limiti di tempo indicati nelle istruzioni: un contatto troppo pro lungato con questi prodotti potrebbe provocare il danneggiamento della superficie.

- Gli eventuali aloni che si dovessero presentare dopo la posa di materiali lappati o levigati si potranno facilmente eliminare utilizzando un prodotto idoneo, a base Alcalina.

- Riguardo l'utilizzo di materiali ceramici all'esterno, pure riconfermando l'ingelività dei prodotti Piemme in gres porcellanato, in conformità alle vigenti normative europee EN 14411/ISO 13006-ISO 10545.12, occorre attenersi ad alcune fondamentali norme previste per la posa all'esterno, atte a rendere inattaccabili al gelo i predetti pavimenti. Le condizioni più importanti da rispettare sono: le opportune pendenze, le impermeabilizzazioni, i giunti di dilatazione, e l'uso di idonei materiali per la posa.

- Decorì realizzati con smalti e metalli preziosi è indispensabile proteggere la superficie durante la posa, non utilizzare assolutamente prodotti abrasivi e/o acidi, ma solo acqua e sapone neutro. Il produttore non risponde di eventuali danni a questi preziosi materiali causati da "sfregamenti" durante la posa in opera. Per nessun motivo saranno accettate contestazioni relative a materialeposato.

TIPO DI SPORCO	INDICAZIONI PER LA PULIZIA
Birra, Caffè, Gelato, Vino Gomma Pneumatico, Grassi vegetali e animali, Inchiostri, Lampostil Olii Meccanici, Residui di scotch Olio di lino, PennarelloResine Smalti, Tintura per capelli	Prodotti a Base Alcalina
Cera protettiva anti-abrasione, Depositi calcarei, Macchie di ruggine	Prodotti a Base Acida
Cera di candela, Residui di scotch	Solventi
Per ulteriori informazioni specifiche consultare l'area tecnica sul sito Piemme: www.ceramichepiemme.it	

- For better installation results of rectified products, we suggest 2 mm joint.

- For a better aesthetic finish, Piemme recommends using jointing colours that match the tiles.

- Please check, before using, the compatibility and suitability of grouting material with the ceramic tile.

- Clean away the excess of grouting materials while they are still fresh.

- Follow carefully the instructions pointed out by the producers of tile grouting materials.

- To completely eliminate installation residues, which could negatively affect routine maintenance and product characteristics once installation has terminated, proceed to clean using adequate products, with max. 3% Acid base, following the manufacturer's instructions. Always closely abide by the time limits indicated in the instructions: prolonged contact with these products may cause damage to the surface.

- Any rims that appear after installing lapped or polished materials can be easily eliminated using a suitable Alkaline-based product.

- With regard to the use of ceramic materials outdoors, while once more reiterating that Piemme porcelain stoneware products are frost-proof, in compliance with applicable European standards EN 14411/ISO 13006-ISO 10545.12, a number of fundamental procedures must be followed for outdoor installation, suitable for making the aforementioned floors resistant to frost. The most important aspects are: suitable gradients, waterproofing, expansion joints, and the use of suitable installation materials.

- Decorations made with glazes and precious metals It is most important to protect the surface during installation. Never use abrasive and/or acid products, only water and neutral soap. The manufacturer disclaims liability in case of any damage to these precious materials caused by "rubbing" during installation. Under no circumstances will disputes be accepted relating to the installed material.

TYPE OF STAIN	CLEANING SUGGESTIONS
beer, coffee, wine, ice cream vegetable and animal fats, rubber, remains of scotch tape, grease from machines, linseed oil, felt tip pens, paints, inks, hair dye	Alkaline-based detergent
protective anti-abrasion wax, calcareous residuals, rust stains	Acid-based detergent
candle wax, remains of scotch-tape	Solvents
For further specific details please visit the technical area on Piemme website: www.ceramichepiemme.it	

- Damit sich eine bessere Verlegung von geschliffenen Produkten ergibt, empfehlen wir eine Fugenbreite von 2 mm.Für ein optisch perfektes Ergebnis empfiehlt Piemme, die Fugen farblich auf die Fliesen abzustimmen.

- Prüfen sie bitte, vor der Verwendung, die Zweckmäßigkeit und die Verträglichkeit des Fugenfüllmittels mit den Keramikfliesen.

- Bitte entfernen sie das überflüssige Fugenfüllmittel wenn es noch frisch ist.

- Folgen sie bitte sorgfältig die von dem Herstellern des Fugenfüllmittels angegebenen Bedienungsvorschriften.

- Zur vollkommenen Entfernung der Verlegerückstände, die die normale Pflege erschweren und die Merkmale des Produkts beeinträchtigen könnten, nach der Verlegung geeignete Reinigungsmittel auf max. 3% Säurebasis verwenden und bei der Reini gung die Hinweise des Herstellers beachten. Die angegebenen Zeiten keinesfalls überschreiten: ein zu lange andauernder Kontakt mit diesen Produkten kann Beschädigungen der Oberfläche verursachen.

- Eventuelle nach der Verlegung von geläppter oder geschliffenem Material sichtbare Schleier lassen sich einfach mit entsprechenden, alkalischen Produkten entfernen.

- Auch wenn die Piemme-Feinsteinzeugprodukte gemäß den europäischen Normen EN 14411/ISO 13006-ISO 10545.12 frostbeständig sind, müssen beim Einsatz keramischer Materialien im Freien einige Grundregeln beachtet werden, damit die Bodenbeläge nicht vom Frost angegriffen werden können. Die wichtigsten Voraussetzungen sind: korrektes Gefälle, Abdichtung, Dehnungsfugen sowie geeignetes Verlegematerial.

- Dekore mit Glasuren und Edelmetallen Während der Verlegung muss die Oberfläche unbedingt abgedeckt werden. Es dürfen keine scheuernden und/oder säurehaltigen Produkte verwendet werden, sondern ausschließlich Wasser und neutrale Seife. Der Hersteller haftet nicht für eventuelle, während der Verlegung durch Abrieb entstandene Schäden an diesen hochwertigen Materialien. Reklamationen von bereits verlegtem Material werden in keinem Fall akzeptiert.

VERSCHMUTZUNGSART	REINIGUNGSHINWEISE
Bier, Wein, Eis, Kaffee Tierische oder pflanzliche Fette Gummi, Kleberbandresten Schmieröl, Tinte, Leöl, Filzstift, Harz oder Lack, Haarfarbe	Alkalische Reinigungsmittel
Kratzenschutz-Wachs, Kalkablagerunge, Rostflecken	Säure-Reinigungsmittel
Kerzenwachs Kleberbandresten	Lösungsmittel
Weitere Einzelheiten finden Sie in dem technischen Bereich des Piemme website: www.ceramichepiemme.it	

- Pour obtenir le meilleur résultat de pose de produits rectifiés, il est conseillé de réaliser un joint de 2 mm.

- Pour parfaire l'effet esthétique obtenu, Piemme conseille de confectionner des joints de la même couleur que les carreaux.

- Vérifier avant la pose la compatibilité et convenance des remplissages pour joints avec le produit céramique.

- Enlever les surplus des remplissages pour joints alors qu'ils sont encore frais.

- Respecter scrupuleusement les instructions indiquées par les fabricants de remplissages pour joints.

- Pour éliminer complètement tout résidu de pose pouvant gêner l'entretien courant et altérer les caractéristiques du produit, il est conseillé, à la fin de la pose, de procéder au nettoyage du carrelage avec des produits à base acide maximum 3% et de respecter les consignes du fabricant. Suivre impérativement les délais indiqués dans la notice car le contact trop prolongé de ces produits pourrait endommager la surface.

- Pour éliminer facilement la présence éventuelle de cernes après la pose de carreaux rodés ou polis, utiliser un produit à base alcaline.

- Pour ce qui est de la pose à l'extérieur, bien que les produits Piemme en grès cérame soient ingélifs, conformément aux normes européennes EN 14411/ISO 13006-ISO 10545.12, il convient cependant de respecter quelques règles fondamentales de manière à rendre le carrelage inattaquable au gel. Les conditions les plus importantes à remplir sont: le degré d'inclinaison, l'imperméabilisation, les joints de dilatation et l'utilisation de matériaux de pose appropriés.

- Décors réalisés avec des émaux et des métaux précieux Il est indispensable de protéger la surface pendant la pose. N'utiliser en aucun cas des produits abrasifs et/ou acides mais uniquement de l'eau et du savon neutre. La fabricant ne répond pas des dommages éventuels de ces matériaux précieux causés par le frottement pendant la pose. Aucune réclamation, quelle qu'elle soit, concernant le matériau posé ne sera acceptée.

TYPE DE TACHE	NETTOYAGE CONSEIL
Bière, Vin, Glace, Café, Graisses végétales et animales, Encres, Résidus de scotch, Huile de graissage, Hile de lin Crayon feutre Émaux, Teinture pour cheveux, Caoutchouc pour pneus	Détergents à base alcaline
Cire de protection anti abrasion, Dépôts de calcaire, Tache de rouille	Détergents à base d'acide
Cire de bougie Résidus de scotch	Solvant
Pour d'ultérieures Information spécifiques consulter le département technique du site Piemme: www.ceramichepiemme.it	

Guida alla Lettura

Reading Guide

Leseanleitung

Guide à la lecture

▼
▲
Spessore
Thickness
Stärke
Epaisseur

Variazione nelle sfumature di colore
Color shade variations
Variation der Farbnuancen
Variation des nuances de couleur

Resistenza alla scivolosità
Skid resistance
Rutschfestigkeit
Resistance au glissement

V1

Aspetto uniforme
Uniform apperance
Gleichförmiges aussehen
Aspect uniforme

V2

Variazione leggera
Slight variation
Leichte variation
Variation légère

V3

Variazione moderata
Moderate variation
Mäßige variation
Variation modeste

V4

Variazione casuale
Random variation
Zufällige variation
Variation fortuite

Tutti i formati sono nominali.

All sizes are nominal.

Die Formate sind Nennwerte.

Tous les formats sont nominaux.

Gli spessori riportati in questo catalogo sono nominali e possono variare a seconda dei formati e delle finiture.

The thickness mentioned on this catalogue are nominal and can be different according to the sizes and the finishes.

Die in diesem Katalog angegebenen Fliesenstärke sind nominal und können, je nach Format oder Oberfläche, verschieden sein.

Les épaisseurs reportées sur ce catalogue sont nominales et peuvent varier suivant les formats et les finitions.

I colori e le caratteristiche estetiche dei prodotti sono quanto più possibile vicini a quelli reali, nei limiti consentiti dai processi di stampa.

The colours and appearance features of the products are as close as possible to reality, within the limitation of the printing process.

Die Farben und die ästhetischen Eigenschaften der Produkte entsprechen der Wirklichkeit, innerhalb den von dem Druckverfahren erlaubten Grenzen.

Les couleurs et les caractéristiques esthétiques sont fidèles aux couleurs et caractéristiques réelles dans les limites des procédés d'impression.



Ceramics of Italy rappresenta la volontà dell'industria italiana delle piastrelle di ceramica nel diffondere e promuovere una nuova valenza della piastrella di ceramica: non più solo un prodotto per l'industria delle costruzioni, ma punto di riferimento per stile e creatività per lo sviluppo di una nuova cultura dell'abitare Made in Italy.

Ceramics of Italy represents the willingness of the Italian ceramic tile industry to spread and promote a new concept of ceramic tile: no longer just a product for the construction industry, but a focal point for style and creativity in the development of a new culture of living Made in Italy.

Project Management
Mktg Piemme

Una storia tutta italiana

Piemme dal 1962, anno della sua fondazione, è protagonista indiscussa del vero Made in Italy, quello fatto di eccellenza, passione e creatività. Oggi tutti i materiali Piemme sono prodotti con tecnologia d'avanguardia come la decorazione digitale inkjet HD, la cottura in forni ad energia pulita a recupero di calore, la rettifica e levigatura in linea "one roof" e la verifica elettronica dello standard qualitativo.

An all-Italian story

Since 1962, the year of its foundation, Piemme has been the undisputed protagonist of real Made in Italy, that which consists of excellence, passion and creativity. Today, all Piemme materials are made using cuttingedge technology such as HD inkjet digital decoration, firing in heat-recycling cleanenergy kilns, "one roof" grinding and polishing line and electronic quality standard control.

Eine ganz italienische Geschichte

Seit dem Gründungsjahr 1962 ist Piemme ein unangefochtener Hauptakteur des echten Made in Italy: jenem, das auf Exzellenz, Leidenschaft und Kreativität gründet. Alle Piemme Erzeugnisse werden heute unter Einsatz von Spitzentechnologie produziert, wie zum Beispiel mit der digitalen Inkjet-Dekoration, dem Brennen in Öfen mit grüner Energie und Wärmerückgewinnung, dem Schleifen und Polieren in der Linie „unter einem Dach“ sowie der elektronischen Prüfung des Qualitätsniveaus.

Une histoire toute italienne

Depuis 1962, l'année de sa fondation, Piemme est la protagoniste indiscutée du Made in Italy, basé sur l'excellence, la passion et la créativité. Aujourd'hui toutes les phases du cycle de fabrication Piemme sont issues d'une technologie à l'avant-garde comme la décoration numérique inkjet HD, la cuisson dans des fours à énergie propre et à récupération de chaleur, la rectification et le polissage en en ligne "one roof" et la vérification électronique de la qualité.

CERAMICHE PIEMME

FLOOR AND MORE

INDUSTRIE CERAMICHE PIEMME S.P.A.
VIA DEL CROCIALE 42/44, 41042 FIORANO (MO) - ITALY
T. +39 0536.849111 - F. +39 0536.849402
WWW.CERAMICHEPIEMME.IT - INFO@CERAMICHEPIEMME.IT