

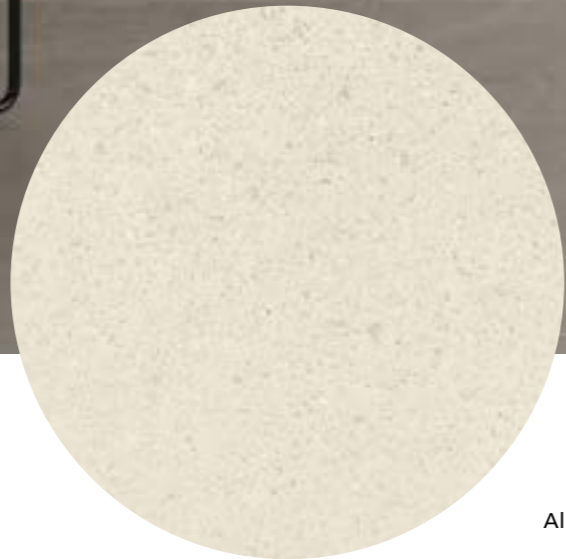

Alley 4D

Porcelain tiles



Alley White_50*100

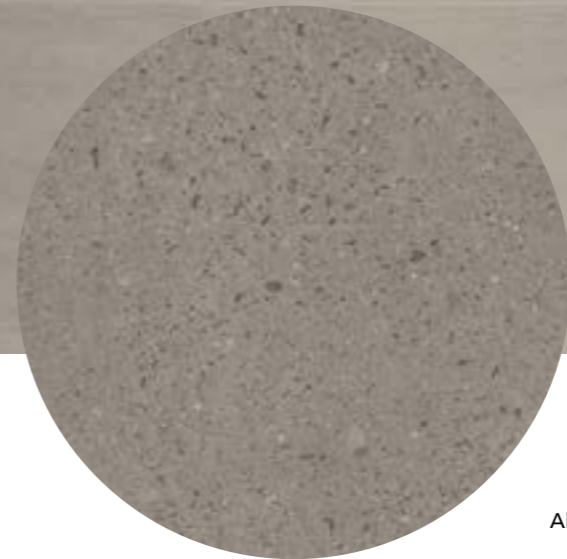

Alley Grey_100*100 Alley Grey_100*100 BH



Alley Mud_100*100 BH

Alley 4D

Porcelain tiles

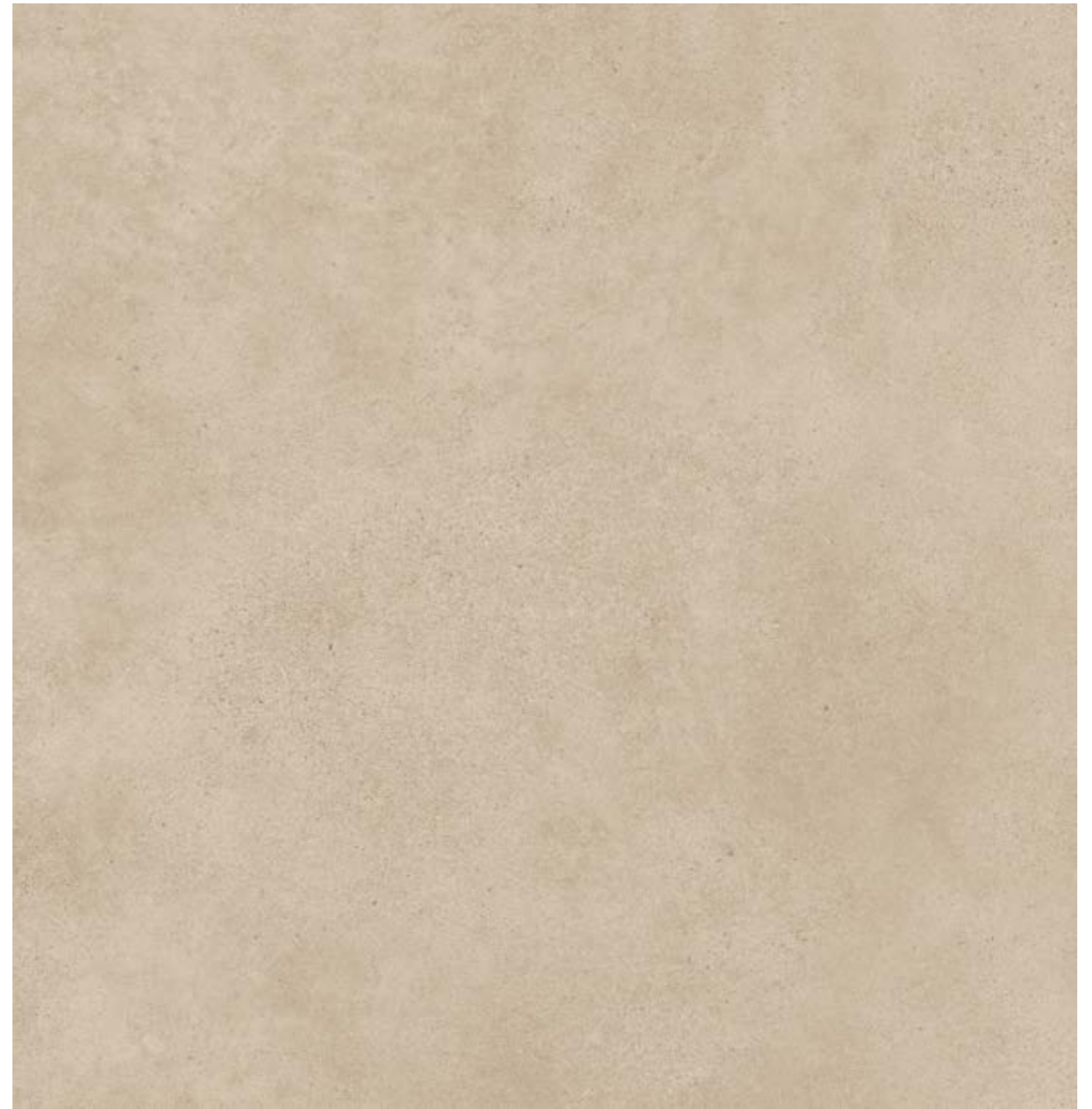

ALLEY White



ALLEY Bone



ALLEY Mud



ALLEY Grey



ALLEY Anthracite





Alley 4D

Porcelain tiles

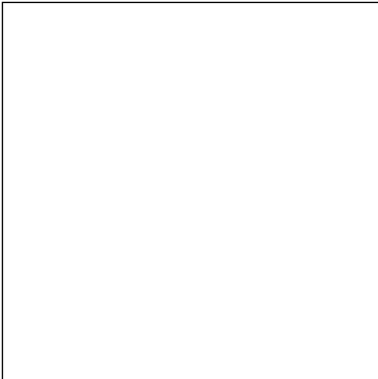
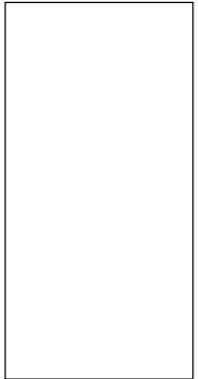

8 mm - 5/16"
THICKNESS

ALLEY 4D

																																																																																																				
9 patterns	18 patterns	36 patterns	54 patterns																																																																																																	
100 * 100 * 0,8 cm 39 * 39"	50 * 100 * 0,8 cm 20 * 39"	24 * 100 * 0,8 cm 10 * 39"	15,5 * 100 * 0,8 cm 6 * 39"																																																																																																	
<table border="1"> <thead> <tr> <th>RECTIFIED</th> <th colspan="2">NATURAL</th> <th colspan="2">ANTISLIP BUSH HAMMERED</th> </tr> <tr> <th></th> <th>BN94</th> <th>BN110</th> <th>BN99</th> <th>BN112</th> </tr> </thead> <tbody> <tr> <td>WHITE</td> <td>-</td> <td>23396</td> <td>-</td> <td>23401</td> </tr> <tr> <td>BONE</td> <td>23398</td> <td>-</td> <td>23403</td> <td>-</td> </tr> <tr> <td>GREY</td> <td>23397</td> <td>-</td> <td>23402</td> <td>-</td> </tr> <tr> <td>MUD</td> <td>23399</td> <td>-</td> <td>23404</td> <td>-</td> </tr> <tr> <td>ANTHRACITE</td> <td>23400</td> <td>-</td> <td>23405</td> <td>-</td> </tr> </tbody> </table>	RECTIFIED	NATURAL		ANTISLIP BUSH HAMMERED			BN94	BN110	BN99	BN112	WHITE	-	23396	-	23401	BONE	23398	-	23403	-	GREY	23397	-	23402	-	MUD	23399	-	23404	-	ANTHRACITE	23400	-	23405	-	<table border="1"> <thead> <tr> <th>RECTIFIED</th> <th colspan="2">NATURAL</th> <th colspan="2">ANTISLIP BUSH HAMMERED</th> </tr> <tr> <th></th> <th>BN96</th> <th>BN111</th> <th>BN103</th> <th>BN113</th> </tr> </thead> <tbody> <tr> <td>WHITE</td> <td>-</td> <td>23406</td> <td>-</td> <td>23411</td> </tr> <tr> <td>BONE</td> <td>23408</td> <td>-</td> <td>23413</td> <td>-</td> </tr> <tr> <td>GREY</td> <td>23407</td> <td>-</td> <td>23412</td> <td>-</td> </tr> <tr> <td>MUD</td> <td>23409</td> <td>-</td> <td>23414</td> <td>-</td> </tr> <tr> <td>ANTHRACITE</td> <td>23410</td> <td>-</td> <td>23415</td> <td>-</td> </tr> </tbody> </table>	RECTIFIED	NATURAL		ANTISLIP BUSH HAMMERED			BN96	BN111	BN103	BN113	WHITE	-	23406	-	23411	BONE	23408	-	23413	-	GREY	23407	-	23412	-	MUD	23409	-	23414	-	ANTHRACITE	23410	-	23415	-	<table border="1"> <thead> <tr> <th>RECTIFIED</th> <th>NATURAL</th> <th>RECTIFIED</th> <th>NATURAL</th> </tr> <tr> <th></th> <th>BN109</th> <th></th> <th>BN108</th> </tr> </thead> <tbody> <tr> <td>WHITE</td> <td>23800</td> <td>WHITE</td> <td>23805</td> </tr> <tr> <td>BONE</td> <td>23801</td> <td>BONE</td> <td>23806</td> </tr> <tr> <td>GREY</td> <td>23802</td> <td>GREY</td> <td>23807</td> </tr> <tr> <td>MUD</td> <td>23803</td> <td>MUD</td> <td>23808</td> </tr> <tr> <td>ANTHRACITE</td> <td>23828</td> <td>ANTHRACITE</td> <td>23809</td> </tr> </tbody> </table>	RECTIFIED	NATURAL	RECTIFIED	NATURAL		BN109		BN108	WHITE	23800	WHITE	23805	BONE	23801	BONE	23806	GREY	23802	GREY	23807	MUD	23803	MUD	23808	ANTHRACITE	23828	ANTHRACITE	23809
RECTIFIED	NATURAL		ANTISLIP BUSH HAMMERED																																																																																																	
	BN94	BN110	BN99	BN112																																																																																																
WHITE	-	23396	-	23401																																																																																																
BONE	23398	-	23403	-																																																																																																
GREY	23397	-	23402	-																																																																																																
MUD	23399	-	23404	-																																																																																																
ANTHRACITE	23400	-	23405	-																																																																																																
RECTIFIED	NATURAL		ANTISLIP BUSH HAMMERED																																																																																																	
	BN96	BN111	BN103	BN113																																																																																																
WHITE	-	23406	-	23411																																																																																																
BONE	23408	-	23413	-																																																																																																
GREY	23407	-	23412	-																																																																																																
MUD	23409	-	23414	-																																																																																																
ANTHRACITE	23410	-	23415	-																																																																																																
RECTIFIED	NATURAL	RECTIFIED	NATURAL																																																																																																	
	BN109		BN108																																																																																																	
WHITE	23800	WHITE	23805																																																																																																	
BONE	23801	BONE	23806																																																																																																	
GREY	23802	GREY	23807																																																																																																	
MUD	23803	MUD	23808																																																																																																	
ANTHRACITE	23828	ANTHRACITE	23809																																																																																																	

D. ALLEY MOSAIC

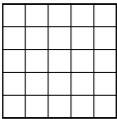
																					
25 * 25 cm 10 * 10"																					
<table border="1"> <thead> <tr> <th>NO RECTIFIED</th> <th>NATURAL</th> <th>ANTISLIP BUSH HAMMERED</th> </tr> <tr> <th></th> <th>P39</th> <th>P39</th> </tr> </thead> <tbody> <tr> <td>WHITE</td> <td>23485</td> <td>23491</td> </tr> <tr> <td>BONE</td> <td>23482</td> <td>23487</td> </tr> <tr> <td>GREY</td> <td>23483</td> <td>23489</td> </tr> <tr> <td>MUD</td> <td>23484</td> <td>23490</td> </tr> <tr> <td>ANTHRACITE</td> <td>23481</td> <td>23488</td> </tr> </tbody> </table>	NO RECTIFIED	NATURAL	ANTISLIP BUSH HAMMERED		P39	P39	WHITE	23485	23491	BONE	23482	23487	GREY	23483	23489	MUD	23484	23490	ANTHRACITE	23481	23488
NO RECTIFIED	NATURAL	ANTISLIP BUSH HAMMERED																			
	P39	P39																			
WHITE	23485	23491																			
BONE	23482	23487																			
GREY	23483	23489																			
MUD	23484	23490																			
ANTHRACITE	23481	23488																			

D. ALLEY BRICK

														
29,8 * 29,2 cm 12 * 12"														
<table border="1"> <thead> <tr> <th>NO RECTIFIED</th> <th>NATURAL</th> </tr> <tr> <th></th> <th>P50</th> </tr> </thead> <tbody> <tr> <td>WHITE</td> <td>23497</td> </tr> <tr> <td>BONE</td> <td>23494</td> </tr> <tr> <td>GREY</td> <td>23495</td> </tr> <tr> <td>MUD</td> <td>23496</td> </tr> <tr> <td>ANTHRACITE</td> <td>23493</td> </tr> </tbody> </table>	NO RECTIFIED	NATURAL		P50	WHITE	23497	BONE	23494	GREY	23495	MUD	23496	ANTHRACITE	23493
NO RECTIFIED	NATURAL													
	P50													
WHITE	23497													
BONE	23494													
GREY	23495													
MUD	23496													
ANTHRACITE	23493													

 **22303** ALUMINIO/100/MAT _ 100 * 0,5 cm | 39 * 0,2" _ P42

 **26153** L. GOLDEN/MAT/100 _ 100 * 0,5 cm | 39 * 0,2" _ P42

EMBALAJE | PACKING

(Los pesos aquí reflejados pueden sufrir ligeras variaciones en función del lote de producción. Weights shown here may slightly vary depending on the production lot.)

Formato Sizes	Cajas Boxes			Pallet				Cont./20' 21500 kg	Cont./20' 24000 kg
cm	Piezas	m ² /sq.m	kg	Cajas	m ² /sq.m	kg	Tamaño cm aprox.	m ² /sq.m	m ² /sq.m
100 * 100 * 08	2	2	37	32	64	1226	112 * 112 * 64	1122,35	1252,85
50 * 100 * 0,8	3	1,50	28,20	24	36	719	120 * 80 * 66	1076,50	1201,67
15,5 * 100 * 0,8	8	1,24	22,9	32	39,68	774,6	112 * 112 * 56	1101,27	1229,32
24 * 100 * 0,8	4	0,96	17,7	40	38,4	731,8	120 * 80 * 63	1128,18	1259,36
inch	units	ft ²	lb	Boxes	ft ²	lb	Sizes Inch approx.	ft ²	ft ²
39 3/8 * 39 3/8 * 5/16	2	21,53	81,59	32	688,90	2703,33	44 1/16 * 44 1/16 * 25 3/16	12080,97	13485,73
19 11/16 * 39 3/8 * 5/16	3	16,15	62,18	24	387,50	1585,40	47 1/4 * 31 1/2 * 26	11587,39	12934,76
6 1/8 * 39 3/8 * 5/16	8	13,34	50,48	32	427,11	1708,15	44 1/16 * 44 1/16 * 22 1/16	11853,92	13232,28
9 7/16 * 39 3/8 * 5/16	4	10,33	39,02	40	413,33	1613,62	47 1/4 * 44 1/16 * 24 13/16	12143,59	13555,63

PIEZA COMPLEMENTARIA | COMPLEMENTARY PIECE

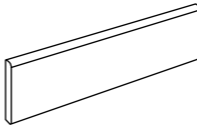
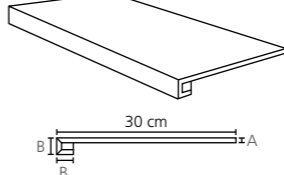
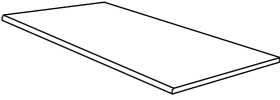
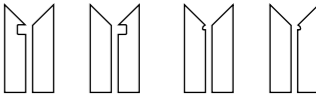





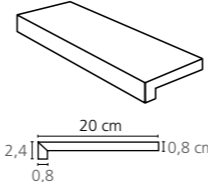
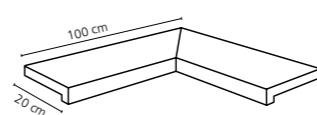
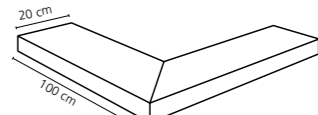
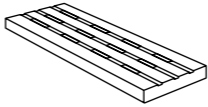
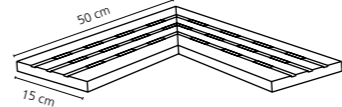
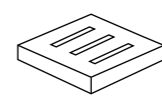

Rodapie - Skirting	Peldaño técnico - Technical stair - thread	Peldaño romo - Rounded stair - thread	*S.K.I.	*S.K.D.	*Z.R.I.	*Z.R.D.
						
8*100 cm 4 * 39" P45	30*100 cm 12 * 39" P74 A= 0,8 cm B= 2,4 cm	30*100 cm 12 * 39" P85				8*30 cm 4*12" P53

PIEZA ESPECIAL PISCINA | SPECIAL PIECE POOL

*Pedido mínimo 10 unidades | Minimum order 10 items

Peldaño Vierteagua Pool Coping	Peldaño vierteagua angulo Pool Coping internal corner	Peldaño vierteagua esquina Pool Coping external corner
		
20 * 100 cm 8 * 39" P82	20 * 100 cm 39 * 39" P80 (PACK 2 units)	20 * 100 cm 39 * 39" P80 (PACK 2 units)
Rejilla Drainage grate	Angulo rejilla Angle corner drainage grate	Taco rejilla Square corner drainage grate
		
15 * 50 * 1,6 cm 6 * 20" P87	15 * 50 * 1,6 cm 20 * 20" P74 (PACK 2 units)	15 * 15 * 1,6 cm 6 * 6" P66

CARACTERÍSTICAS TÉCNICAS | TECHNICAL CHARACTERISTICS

joint	frost proof	versatile	matt	full body	diferent shades	shade variation	various graphics	thickness
								

CARACTERÍSTICAS TÉCNICAS ANTIDESLIZAMIENTO | ANTI-SLIP CHARACTERISTICS

Ensayo Essay	Características Features	Resultado Result	
		NATURAL	ANTISLIP BUSH HAMMERED
DIN 51130	Ángulo crítico (Pies calzados) Critical angle (footwear)	R9	R11
DIN 51097	Ángulo crítico (Pies descalzos) Critical angle (Wet loaded barefoot)	-	A+B+C
BS 7976-2	Antideslizamiento (Test del péndulo) Slip resistance (Pendulum test-PTV)	-	+36 Wet
UNE-ENV 12633	Antideslizamiento (Test del péndulo) Slip resistance (Pendulum test)	Class 1	Class 3
ANSI A137.1	Coefficiente de Fricción Dinámico Dynamic Coefficient of Friction (DCOF)	>0,42	>0,42
ISO 10545-6	Resistencia a la abrasión profunda/ Resistance to Deep Abrasion	< 175 mm ³	< 175 mm ³