



ORIGINALSTYLE

Glassworks



reflect on the brilliance of glass

Glass. It's been used in the decoration of buildings for a thousand years or more, and its reflective qualities are continually being redefined. Enjoy the translucent beauty of this versatile and colourful material on interior walls throughout the home with our latest Glassworks Collection.

Explore the following pages for large splashbacks, stunning decorative effects, beautiful metallics, mosaics in hexagon and brickbond formats, and a whole spectrum of colours in both glossy and frosted finishes, reflecting the latest trends in interior design.

Front cover: Copper Leaf Bold GW-CFBLP6030 shown with Krea Ash Slip Resistant wood effect planks from the Tileworks Collection

This page: Antique Mirror Grey GW-ANTGR6030

Contents

Large format **04**

A host of designs from precious metal foils to futuristic patterns

Cast glass **32**

Bricks and mosaics in stunning rainbow effects and rich, deep colours

Metallic and sparkling **40**

Sophisticated and subtle, metallic and sparkling effect tiles look great in bathrooms and kitchens

Mirror **58**

Highly reflective pieces, some with antique effects

Splashbacks and upstands **66**

Two sizes and numerous colour options in speciality glass for kitchens and beyond, with matching upstands

Clear and frosted **76**

Tiles in many colours, different formats and sizes with a glossy or frosted finish

Important information **93**



04

DECORATIVE
LARGE FORMAT

Go large

Large format glass tiles can be used to transform a room, reflect light or to create dazzling effects.

Choose from a host of designs from precious metal foils to futuristic patterns. See pages 26-31 for the full range





Large format
decoratives





Silver Leaf GW-SLF6030 shown with Viano White marble from the Earthworks Collection

Take a leaf

new
designs
added

Sheets of incredibly thin real gold, silver and copper are used to create the striking effects in these large format tiles. For subtly nuanced patterns go for Gold, Silver and Copper Leaf, or choose the highly textured Bold versions for more of a statement.

08

DECORATIVE
LARGE FORMAT



Gold Leaf GW-GLF6030

Masterpieces of precious metal encapsulated in glass. These copper leaf tiles will make a striking first impression wherever they are used.





Copper Leaf Bold GW-CFBLP6030 shown with Krea Ash Slip Resistant wood effect planks from the Tileworks Collection





Spun Silk GW-WWSLV6030 detail

A fine line

new
design

Look closely at Spun Silk and you'll see a network of silk-like threads beneath the surface. Then stand back and you'll fully appreciate the overall effect of this decorative tile.

12

DECORATIVE
LARGE FORMAT

Lavish living

It's the very opposite of minimalism.
There's an opalescent depth to these tiles –
why not echo these textures by furnishing the
room with sumptuous fabrics and rich colours?







NOBLE ISLE
THE NEW TRADITION
HEATHER HONEY
PERTHSHIRE DIST
HAND LOTION

NOBLE ISLE
THE NEW TRADITION
HEATHER HONEY
PERTHSHIRE DIST
ESSENCE OF
PERFUME



15
DECORATIVE
LARGE FORMAT

Tutankhamun GW-TUT6030

A glass act

Although it doesn't look like it, these tiles are actually made from glass – they appear to have been forged from silver or wrought iron. Their intricate designs will add drama to any setting.

16

DECORATIVE
LARGE FORMAT



Graphite Wave GW-GRP6020

Ride the wave

Create a wave of excitement with these textured tiles, available in two distinct styles and three colour options, from bright silver to deep graphite grey.



Silver Crest GW-SCR6030 shown with Fantasy Black and Illusion White polished tiles from the Tileworks Collection



Beauville Black Negative GW-BFB6030N

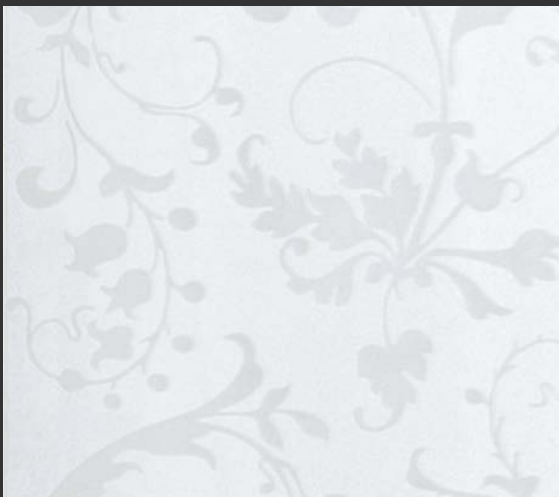

Beauville Silver GW-BFS6030P

The power of flowers

Graceful floral patterns are entwined across these tiles, whether they are placed horizontally or vertically. Clever use of lighting will bring out their shiny and satin features. Beauville is available in Black Positive, Black Negative and Silver. See page 29 for more details.

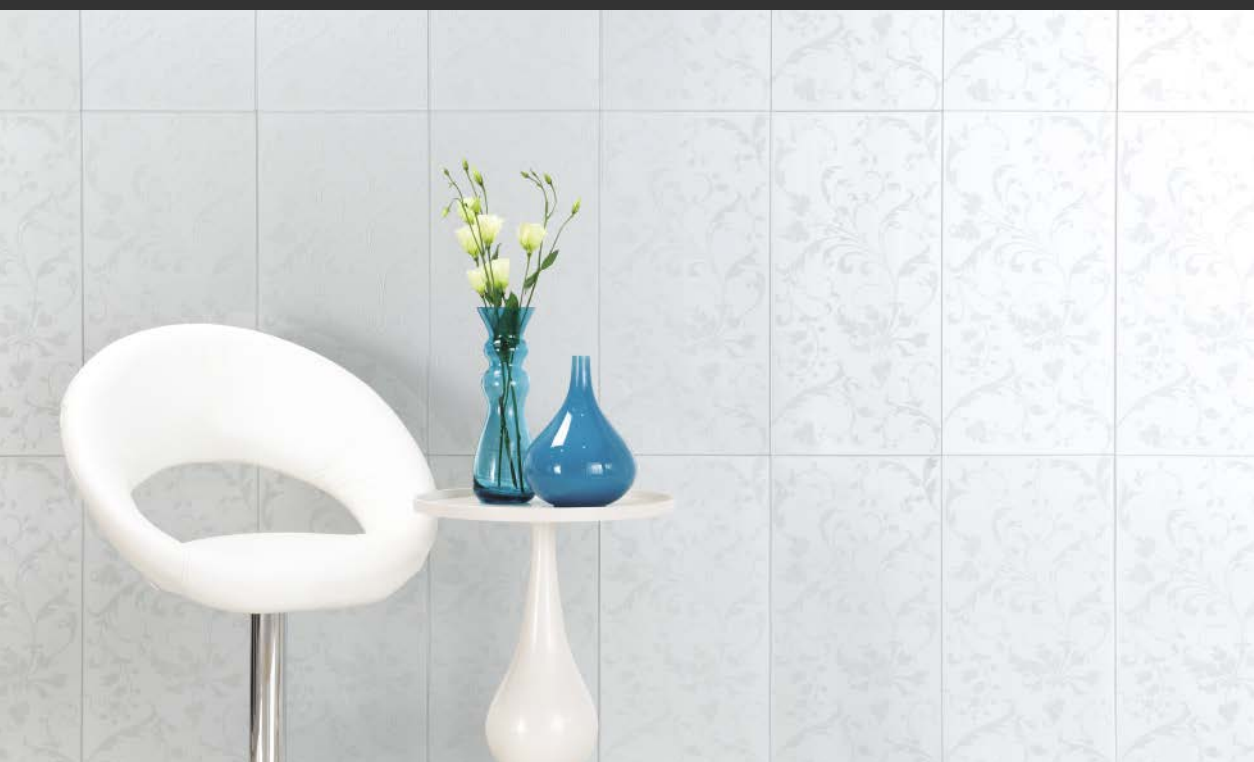

Beauville Silver GW-BFS6030P





20

DECORATIVE
LARGE FORMAT



Arabia GW-ABA6030

Gold treasures

Choose from scrolling leaves etched onto a rich golden background (Honfleur Gold, right) and Arabia's random textured effect (above).







Aurora Borealis Silver GW-SRB6030 shown with Bastille field tiles from the Winchester Residence Collection.

23

DECORATIVE
LARGE FORMAT



Aurora Borealis Dark Silver GW-DSR6030

Hi ho silver

You can create amazing effects with these shimmering silver tiles, such as combining with strong colours for a bold statement bathroom (left).

24

DECORATIVE
LARGE FORMAT



Elevate your style
with a confident
expanse of glass

It's also a practical solution for a
wall covering, as it's quick and easy
to keep clean and looking good.



Solstice GW-SOL6030 shown with Sands Santa Monica Off White Porcelain floor tiles from the Tileworks Collection



Honfleur Gold

GW-HGL6030

600 x 300 x 8mm (11³/₁₆" x 23⁵/₈" x 5¹/₁₆")

A scrolling leafy pattern, seemingly etched onto a gold background



Cleopatra

GW-CLE6030

600 x 300 x 9mm (11³/₁₆" x 23⁵/₈" x 5¹/₁₆")

Incorporates the thinnest layer of real gold foil beneath the glass

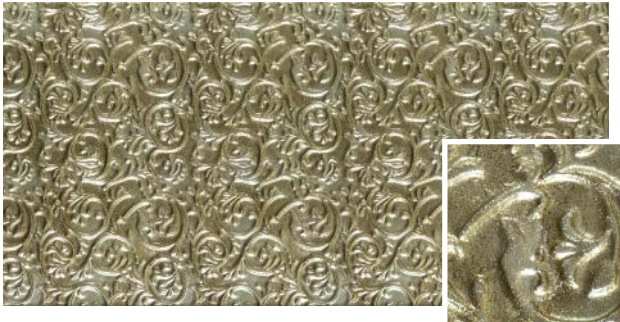

Amun-Ra

GW-AMR6030

600 x 300 x 9mm (11³/₁₆" x 23⁵/₈" x 5¹/₁₆")

Intricate entwining patterns that look like ancient designs, in gold



Gold Leaf

GW-GLF6030

600 x 300 x 9mm (11³/₁₆" x 23⁵/₈" x 5¹/₁₆")

A bright and glossy beaten gold effect to add a touch of glamour



Tutankhamun

GW-TUT6030

600 x 300 x 9mm (11³/₁₆" x 23⁵/₈" x 5¹/₁₆")

Intricate entwining patterns that look like ancient designs, in wrought metal

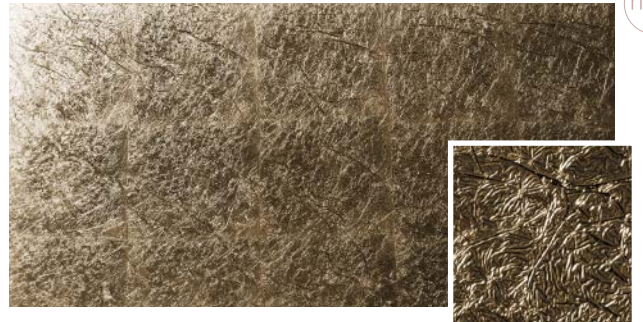

Gold Leaf Bold

GW-GFBLP6030

600 x 300 x 8mm (11³/₁₆" x 23⁵/₈" x 5¹/₁₆")

Incorporates a thin gold leaf effect foil with a pronounced texture

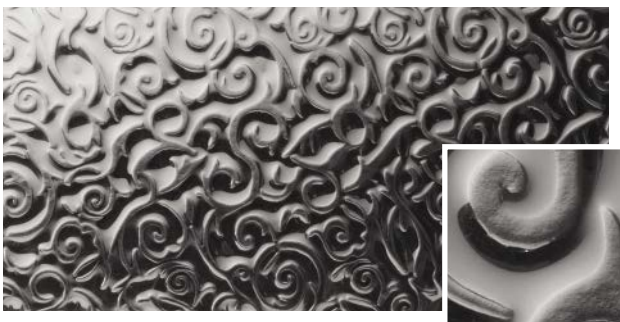

Pharaoh

GW-PHR6030

600 x 300 x 9mm (11³/₁₆" x 23⁵/₈" x 5¹/₁₆")

Intricate entwining patterns that look like ancient designs, in silver

new!



Tiles with a painted backing

Carreaux avec support peint
Fliesen mit gemalter Rückseite
Tegels met een geverfde achterzijde
Плитки с окрашенной обратной стороной

Gold Leaf GW-GLF6030
Amun-Ra GW-AMR6030
Pharaoh GW-PHR6030
Giza GW-GZA6030

Tiles with a vinyl backing

Carreaux avec support en vinyle laminé
Fliesen mit laminiertes Vinylrückseite
Tegels met een gelamineerde vinylachterzijde
Плитки с виниловым покрытием

Silver Leaf GW-SLF6030
Copper Leaf GW-CLF6030
Karnak GW-KNK6030
Cleopatra GW-CLE6030
Tutankhamun GW-TUT6030
Honfleur Gold GW-HGL6030
Gold Leaf Bold GW-GFBLP6030
Copper Leaf Bold GW-CFBLP6030
Silver Leaf Bold GW-SFBLP6030

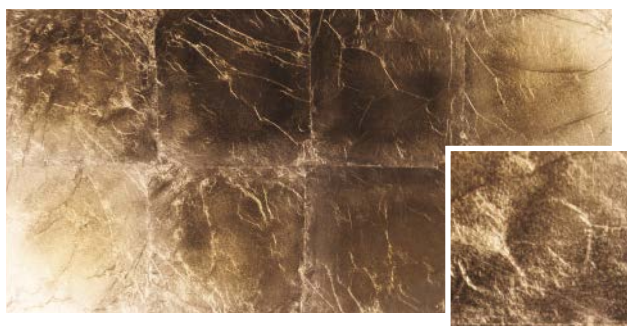

Giza

GW-GZA6030

600 x 300 x 6mm (11³/₁₆" x 23⁵/₈" x 5¹/₁₆")

Incorporates a thin layer of beaten foil beneath the glass surface

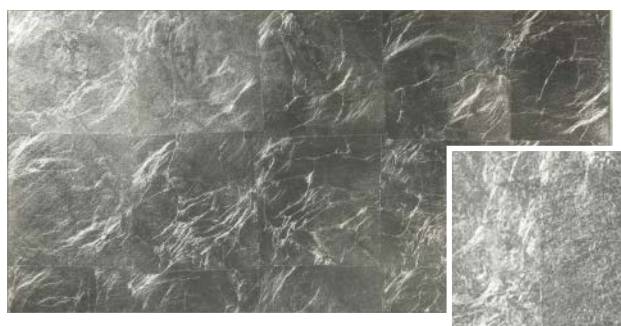

Karnak

GW-KNK6030

600 x 300 x 9mm (11³/₁₆" x 23⁵/₈" x 5¹/₁₆")

Incorporates the thinnest layer of real silver foil beneath the glass



Copper Leaf

GW-CLF6030

600 x 300 x 8mm (11³/₁₆" x 23⁵/₈" x 5¹/₁₆")

Incorporates a thin layer of beaten foil beneath the glass surface



Silver Leaf

GW-SLF6030

600 x 300 x 8mm (11³/₁₆" x 23⁵/₈" x 5¹/₁₆")

Incorporates a thin layer of beaten foil beneath the glass surface

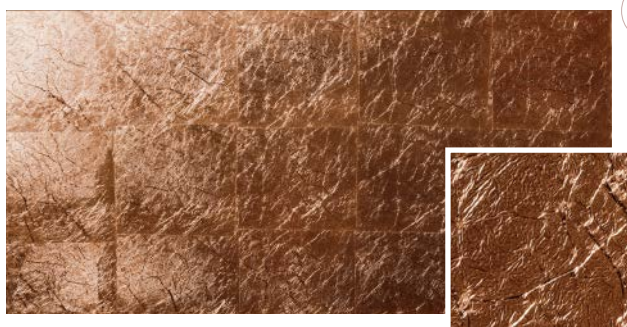

Copper Leaf Bold

GW-CFBLP6030

600 x 300 x 8mm (11³/₁₆" x 23⁵/₈" x 5¹/₁₆")

Incorporates a thin copper leaf effect foil with a pronounced texture



Silver Leaf Bold

GW-SFBLP6030

600 x 300 x 8mm (11³/₁₆" x 23⁵/₈" x 5¹/₁₆")

Incorporates a thin silver leaf effect foil with a pronounced texture



Please note, because of their size, these tiles are not in proportion to reference images of tiles in other sections.

Merci de noter qu'en raison de leur taille ces carreaux ne sont pas en proportion avec les autres images dans les autres sections.

Es ist zu merken, daß diese Fliesen in keinem Verhältniss zu der Abbildungen von Fliesen in anderer Ausschnitten stehen.

De tegels in deze afbeeldingen zijn niet afgebeeld in dezelfde schaal als de tegels afgebeeld in andere secties.

Обратите внимание, что из-за их размера эти плитки не соответствуют ссылочным изображениям плиток в других разделах.



Graphite Wave

GW-GRP6020

600 x 200 x 9mm (7⁷/₈" x 23⁵/₈" x 3³/₈"

A textured wave effect in dramatic black

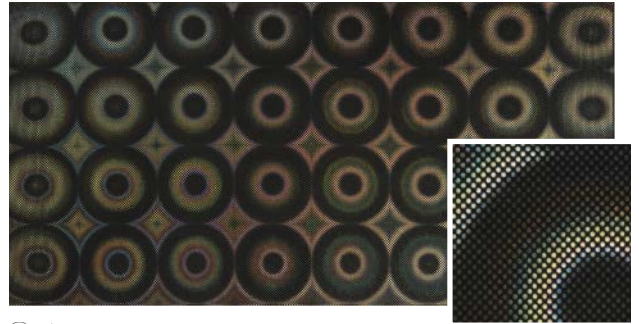

Saturn

GW-STN6030

600 x 300 x 9mm (11¹/₄" x 23⁵/₈" x 3³/₈"

A colourful and complex geometric design

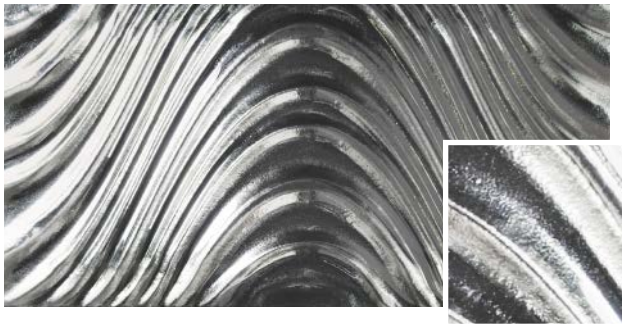

Silver Crest

GW-SCR6030

600 x 300 x 8mm (11¹/₄" x 23⁵/₈" x 5¹/₈"

An undulating silver wave to create a repeating pattern



Solstice

GW-SOL6030

600 x 300 x 9mm (11¹/₄" x 23⁵/₈" x 3³/₈"

Look closely to see a galaxy of stars in a dark night sky

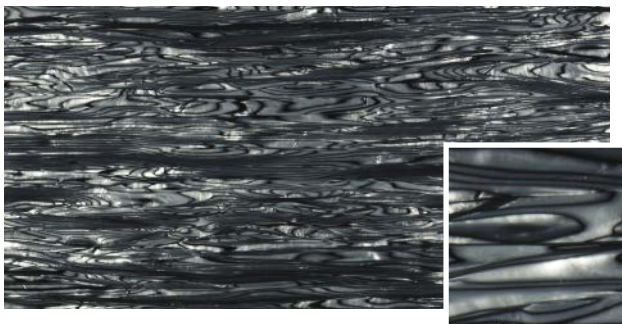

Caeli

GW-CAE6030

600 x 300 x 9mm (11¹/₄" x 23⁵/₈" x 3³/₈"

Similar to Aduro, but with mysterious undertones in grey and black

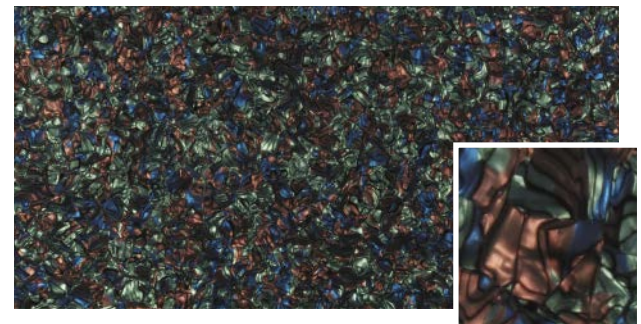

Paua

GW-PAU6030

600 x 300 x 9mm (11¹/₄" x 23⁵/₈" x 3³/₈"

All the vibrant colours of abalone shells



Tiles with a vinyl backing
Carrelages avec revêtement décoratif
Fliesen mit laminiertem Kern
Tegels met een plastic tussenlaag
Плитки с виниловым покрытием

Graphite Wave GW-GRP6020
Saturn GW-STN6030
Silver Crest GW-SCR6030
Solstice GW-SOL6030
Caeli GW-CAE6030
Paua GW-PAU6030
Solar GW-SLR6030
Spun Silk GW-WWSLV6030
Beauville Silver Positive GW-BFS6030P
Beauville Black Positive GW-BFB6030P
Beauville Black Negative GW-BFB6030P

Please note, because of their size, these tiles are not in proportion to reference images of tiles in other sections.

Merci de noter qu'en raison de leur taille ces carreaux ne sont pas en proportion avec les autres images dans les autres sections.

Es ist zu merken, daß diese Fliesen in keinem Verhältnis zu der Abbildungen von Fliesen in anderer Ausschnitten stehen.

De tegels in deze afbeeldingen zijn niet afgebeeld in dezelfde schaal als de tegels afgebeeld in andere secties.

Обратите внимание, что из-за их размера эти плитки не соответствуют ссылочным изображениям плиток в других разделах.

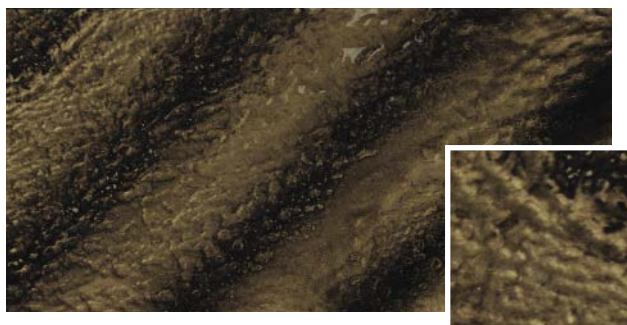

Arabia

GW-ABA6030

600 x 300 x 8mm (11³/₁₆" x 23⁵/₈" x 5¹/₆")

An undulating surface for added interest

Matching mosaic bricks are also available see page 56



Beauville Black Positive

GW-BFB6030P

600 x 300 x 6mm (11³/₁₆" x 23⁵/₈" x 1¹/₄")

Elegant black satin tendrils in a repeating pattern, on black gloss

new!

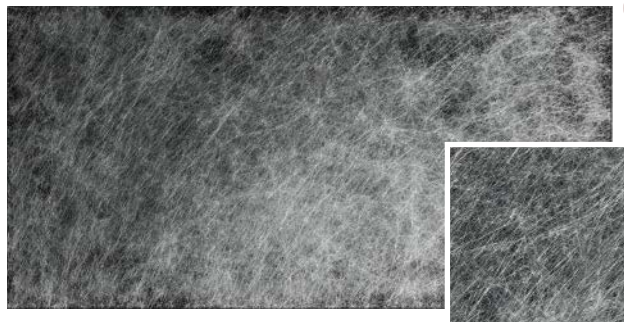

Spun Silk

GW-WWSLV6030

600 x 300 x 8mm (11³/₁₆" x 23⁵/₈" x 5¹/₆")

A complex network silk-like threads on a black background



Beauville Black Negative

GW-BFB6030N

600 x 300 x 6mm (11³/₁₆" x 23⁵/₈" x 1¹/₄")

Elegant black gloss tendrils in a repeating pattern, on black satin

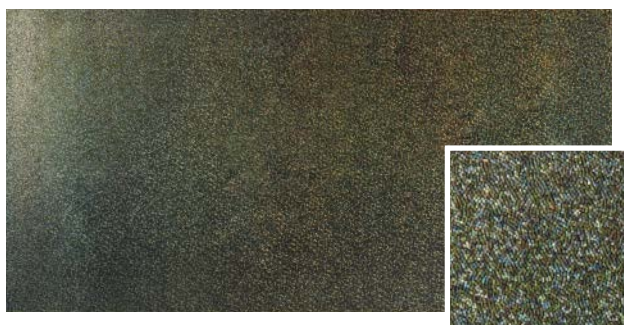

Solar

GW-SLR6030

600 x 300 x 9mm (11³/₁₆" x 23⁵/₈" x 3³/₈")

A tile with a soft glitter and glints of iridescence



Beauville Silver

GW-BFS6030P

600 x 300 x 6mm (11³/₁₆" x 23⁵/₈" x 1¹/₄")

Elegant silver satin tendrils in a repeating pattern, on silver gloss



These tiles and mosaics are painted by hand and so each individual tile will be unique.
Ces carreaux et mosaïques sont peints à la main ; de ce fait chaque carreau sera unique.
Die Rückseiten dieser Fliesen und Mosaiken sind handbemalt und jede Fliese ist einzigartig.
Doordat de achterkant van deze glazen tegels en mozaïeken met de hand geschilderd zijn,
is iedere tegel uniek.
Обратная сторона этой плитки раскрашена вручную и поэтому каждая индивидуальная плитка уникальна.

Arabia GW-ABA6030

30

DECORATIVE
LARGE FORMAT



Aduro

GW-ADR6030

600 x 300 x 9mm (11³/₁₆" x 23⁵/₈" x 3/₈")

Lustrous, pearly effects that shimmer and attract the light

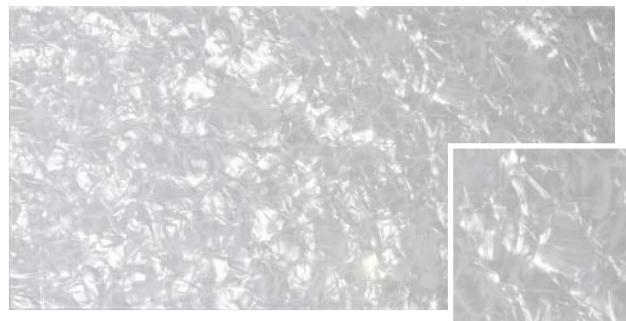

Arctic Crushed Pearl

GW-ACP6030

600 x 300 x 8mm (11³/₁₆" x 23⁵/₈" x 5/₁₆")

Ice white crushed pearl effect, encapsulated in a sheet of glass

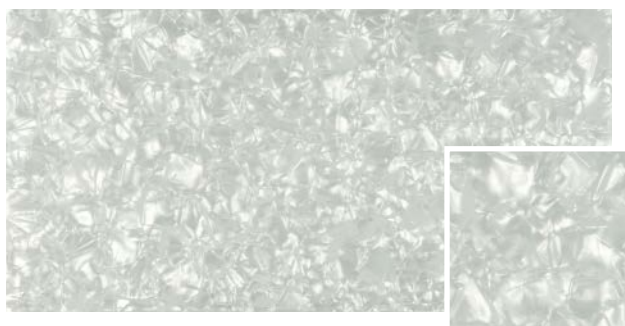

Crushed Pearl

GW-CPL6030

600 x 300 x 9mm (11³/₁₆" x 23⁵/₈" x 3/₈")

The appearance of crushed pearls, encapsulated in a sheet of glass

Please note, because of their size, these tiles are not in proportion to reference images of tiles in other sections.

Merci de noter qu'en raison de leur taille ces carreaux ne sont pas en proportion avec les autres images dans les autres sections.

Es ist zu merken, daß diese Fliesen in keinem Verhältniss zu der Abbildungen von Fliesen in anderer Ausschnitten stehen.

De tegels in deze afbeeldingen zijn niet afgebeeld in dezelfde schaal als de tegels afgebeeld in andere secties.

Обратите внимание, что из-за их размера эти плитки не соответствуют ссылочным изображениям плиток в других разделах.

Tiles with a vinyl backing

Carrelages avec revêtement décoratif

Fliesen mit laminiertem Kern

Tegels met een plastic tussenlaag

Плитки с виниловым покрытием

Aduro GW-ADR6030

Crushed Pearl GW-CPL6030

Arctic Crushed Pearl GW-ACP6030





Aurora Borealis Aura Frosted

GW-AUR6030F

600 x 300 x 6mm (11³/₁₆" x 23⁵/₁₆" x 1/4")

Ever changing pink spectrum rainbow colours, with a frosted finish

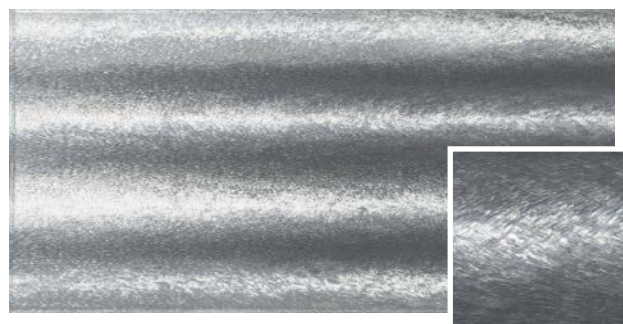

Aurora Borealis Silver

GW-SRB6030

600 x 300 x 6mm (23⁵/₁₆" x 11³/₁₆" X 1/4")

Shimmering silver effects, with a gloss finish



Aurora Borealis Ventus Frosted

GW-VEN6030F

600 x 300 x 6mm (11³/₁₆" x 23⁵/₁₆" x 1/4")

Ever changing blue spectrum rainbow colours, with a frosted finish

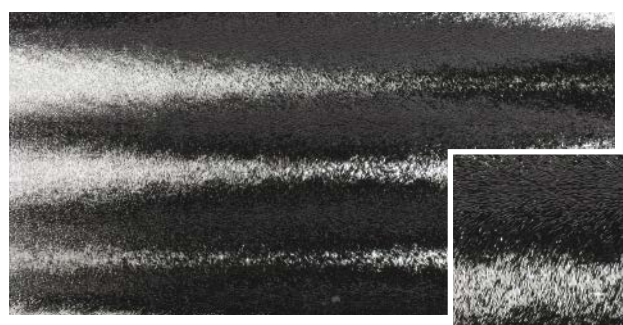

Aurora Borealis Dark Silver

GW-DSR6030

600 x 300 x 6mm (11³/₁₆" x 23⁵/₁₆" x 1/4")

Shimmering dark silver effects, with a gloss finish



Aurora Borealis Aqua Frosted

GW-AQA6030F

600 x 300 x 6mm (11³/₁₆" x 23⁵/₁₆" x 1/4")

Ever changing green - blue spectrum rainbow colours, with a frosted finish

Tiles with a painted backing
Carreaux avec support peint
Fliesen mit gemalter Rückseite
Tegels met een geverfde achterzijde
Плитки с окрашенной обратной стороной

Aurora Borealis Aura Frosted GW-AUR6030F
Aurora Borealis Silver GW-SRB6030
Aurora Borealis Ventus Frosted GW-VEN6030F
Aurora Borealis Dark Silver
Aurora Borealis Aqua Frosted GW-AQA6030F

Because of the way they are made, every Aurora Borealis tile is unique. When they are placed together the patterns will not necessarily match each other but the overall effect will be stunning.

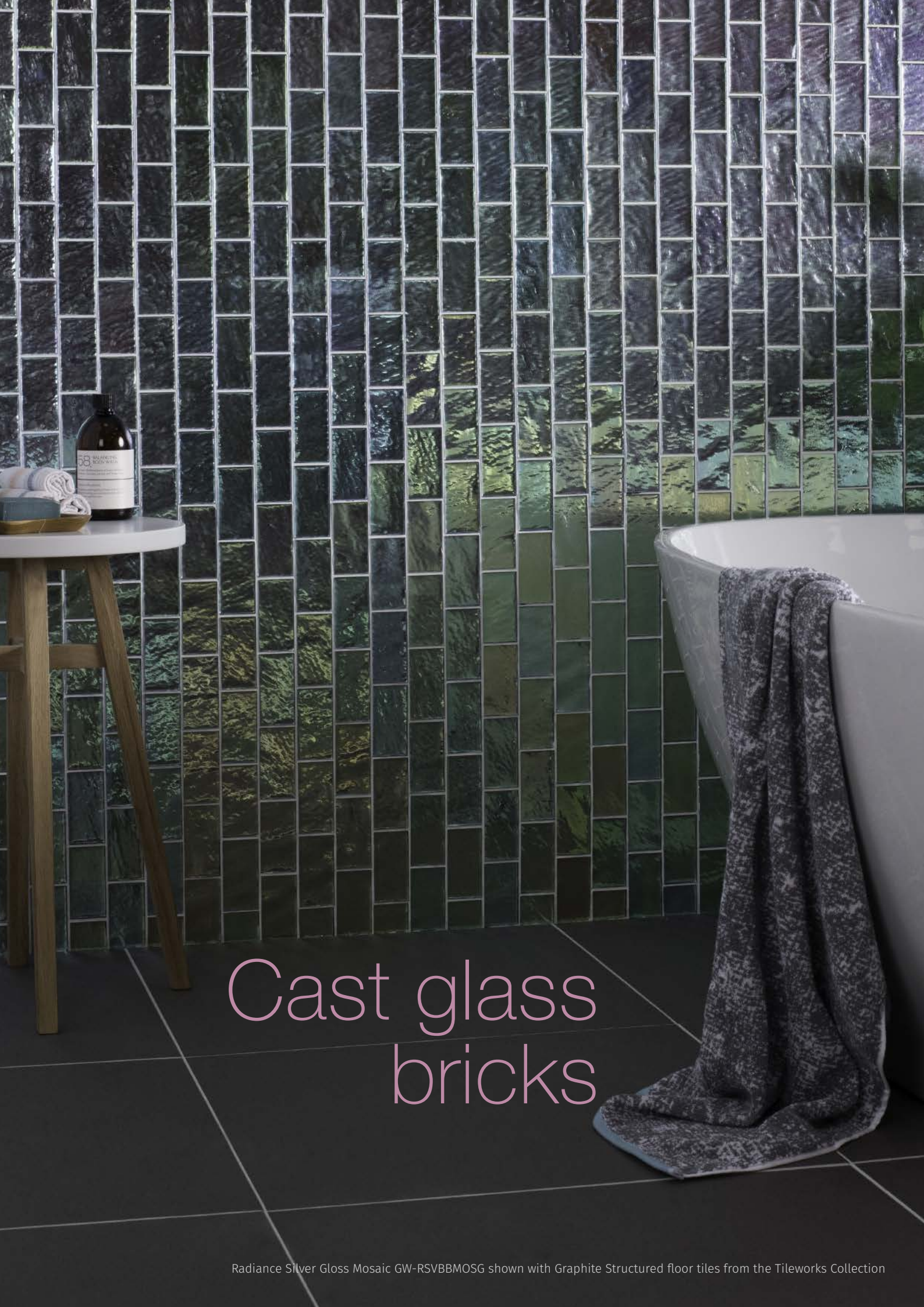

Cast glass bricks



Radiance Pearl Frost GW-RPR2008F and Pink Frost GW-RPK2008F

Light fantastic

new
range

Radiance brick tiles and mosaics positively glow in certain lights. Don't take our word for it, you'll have to see this range of Gloss and Frost for yourself to appreciate the full effect. Turn to pages 34-35 for all the colours and finishes available.

These polished and frosted bricks and mosaics are made by heating glass until it is a liquid, which is then poured into moulds. The resulting pieces are undulating, so the surfaces seem to change under different light conditions. This is enhanced by a reflective coloured backing which gives Radiance their unique glowing appearance. They are made from 80 per cent recycled glass.

Radiance

new
range

Pink Gloss Brick

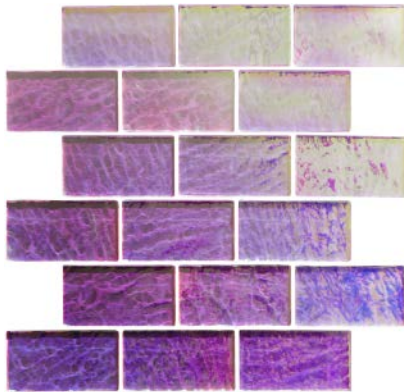
GW-RPK2008G
200 x 75 x 8mm (3" x 7⁷/₈" x 5¹/₁₆"

Pink Gloss Mosaic

GW-RPKBBMOSG
315 x 305 x 8mm (12" x 12³/₈" x 5¹/₁₆"

Pink Frost Brick

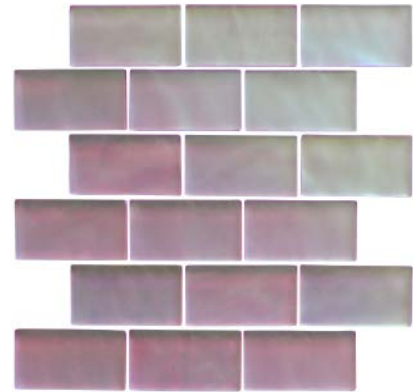
GW-RPK2008F
200 x 75 x 8mm (3" x 7⁷/₈" x 5¹/₁₆"

Pink Frost Mosaic

GW-RPKBBMOSF
315 x 305 x 8mm (12" x 12³/₈" x 5¹/₁₆"

Blue Gloss Brick

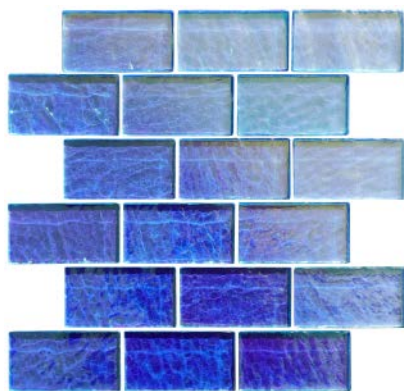
GW-RBL2008G
200 x 75 x 8mm (3" x 7⁷/₈" x 5¹/₁₆"

Blue Gloss Mosaic

GW-RBLBBMOSG
315 x 305 x 8mm (12" x 12³/₈" x 5¹/₁₆"

Blue Frost Brick

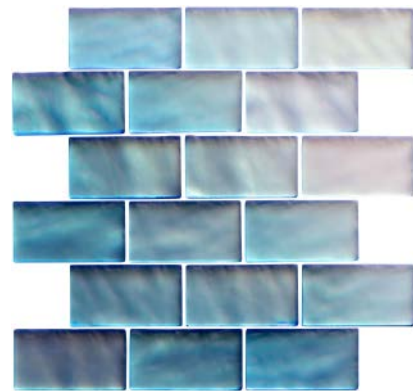
GW-RBL2008F
200 x 75 x 8mm (3" x 7⁷/₈" x 5¹/₁₆"

Blue Frost Mosaic

GW-RBLBBMOSF
315 x 305 x 8mm (12" x 12³/₈" x 5¹/₁₆"

Please note, because of their size, these tiles are not in proportion to reference images of tiles in other sections.
 Merci de noter qu'en raison de leur taille ces carreaux ne sont pas en proportion avec les autres images dans les autres sections.
 Es ist zu merken, daß diese Fliesen in keinem Verhältniss zu der Abbildungen von Fliesen in anderer Ausschnitten stehen.
 De tegels in deze afbeeldingen zijn niet afgebeeld in dezelfde schaal als de tegels afgebeeld in andere secties.
 Обратите внимание, что из-за их размера эти плитки не соответствуют ссылочным изображениям плиток в других разделах.



Pearl Gloss Brick

GW-RPR2008G

200 x 75 x 8mm (3" x 7⁷/₈" x 5¹/₁₆")

Pearl Gloss Mosaic

GW-RPRBBMOSG

315 x 305 x 8mm (12" x 12³/₈" x 5¹/₁₆")

Pearl Frost Brick

GW-RPR2008F

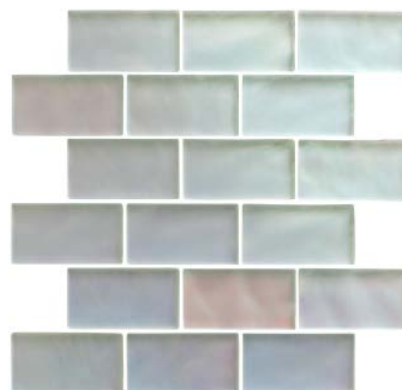
200 x 75 x 8mm (3" x 7⁷/₈" x 5¹/₁₆")

Pearl Frost Mosaic

GW-RPRBBMOSF

315 x 305 x 8mm (12" x 12³/₈" x 5¹/₁₆")

Silver Gloss Brick

GW-RSV2008G

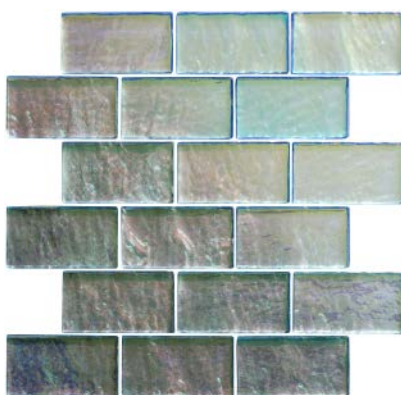
200 x 75 x 8mm (3" x 7⁷/₈" x 5¹/₁₆")

Silver Gloss Mosaic

GW-RSVBBMOSG

315 x 305 x 8mm (12" x 12³/₈" x 5¹/₁₆")

Silver Frost Brick

GW-RSV2008F

200 x 75 x 8mm (3" x 7⁷/₈" x 5¹/₁₆")

Silver Frost Mosaic

GW-RSVBBMOSF

315 x 305 x 8mm (12" x 12³/₈" x 5¹/₁₆")





Eclipse Despina GW-DES2276S

Colour depth

new
range

Like the Radiance range (see page 34) Eclipse bricks are cast glass, which means that they are made from molten glass poured into casts or moulds. The frosted undulating surface takes on a different character dependant on light conditions. The deep colours result from a reflective coloured backing. They are made from 80 per cent recycled glass.



Eclipse Janus GW-JAN2276S shown with Black Flag Natural Slate from the Earthworks Collection

Eclipse Bricks



Deimos

GW-DEI2276S

220 x 76 x 8mm (3" x 8⁵/₈" x 5¹/₁₆"

Dione

GW-DIN2276S

220 x 76 x 8mm (3" x 8⁵/₈" x 5¹/₁₆"

Janus

GW-JAN2276S

220 x 76 x 8mm (3" x 8⁵/₈" x 5¹/₁₆"

Arche

GW-ACH2276S

220 x 76 x 8mm (3" x 8⁵/₈" x 5¹/₁₆"

Amalthea

GW-AML2276S

220 x 76 x 8mm (3" x 8⁵/₈" x 5¹/₁₆"

Belinda

GW-BLN2276S

220 x 76 x 8mm (3" x 8⁵/₈" x 5¹/₁₆"

Leda

GW-LED2276S

220 x 76 x 8mm (3" x 8⁵/₈" x 5¹/₁₆"

Ophelia

GW-OPH2276S

220 x 76 x 8mm (3" x 8⁵/₈" x 5¹/₁₆"

Despina

GW-DES2276S

220 x 76 x 8mm (3" x 8⁵/₈" x 5¹/₁₆"

Elara

GW-ELA2276S

220 x 76 x 8mm (3" x 8⁵/₈" x 5¹/₁₆"

Helene

GW-HLN2276S

220 x 76 x 8mm (3" x 8⁵/₈" x 5¹/₁₆"

Charon

GW-CRN2276S

220 x 76 x 8mm (3" x 8⁵/₈" x 5¹/₁₆"

Please note, because of their size, these tiles are not in proportion to reference images of tiles in other sections.

Merci de noter qu'en raison de leur taille ces carreaux ne sont pas en proportion avec les autres images dans les autres sections.

Es ist zu merken, daß diese Fliesen in keinem Verhältniss zu der Abbildungen von Fliesen in anderer Ausschnitten stehen.

De tegels in deze afbeeldingen zijn niet afgebeeld in dezelfde schaal als de tegels afgebeeld in andere secties.

Обратите внимание, что из-за их размера эти плитки не соответствуют ссылочным изображениям плиток в других разделах.

Metallic and sparkling





Triton GW-TRT610SFT



Dionysus GW-DIO3010C shown with
Purity shell mosaics from the Mosaics Collection

Beautiful blends

The Metallica tiles come in eight colours, which range from the silver of Triton to the deep charcoal of Hermes. See the colours on page 54, and a list of formats on page 88.

42

METALLIC
AND SPARKLING



Starcia GW-SC11575CM

Harmony and style

Combine both with metallics or a hint of sparkle. Brighten up your mornings or add sophistication to a bathroom with a sultry gleam. Tiles, bricks and splashbacks are not just for kitchens and bathrooms either – they can be used to link colour and texture from room to room.



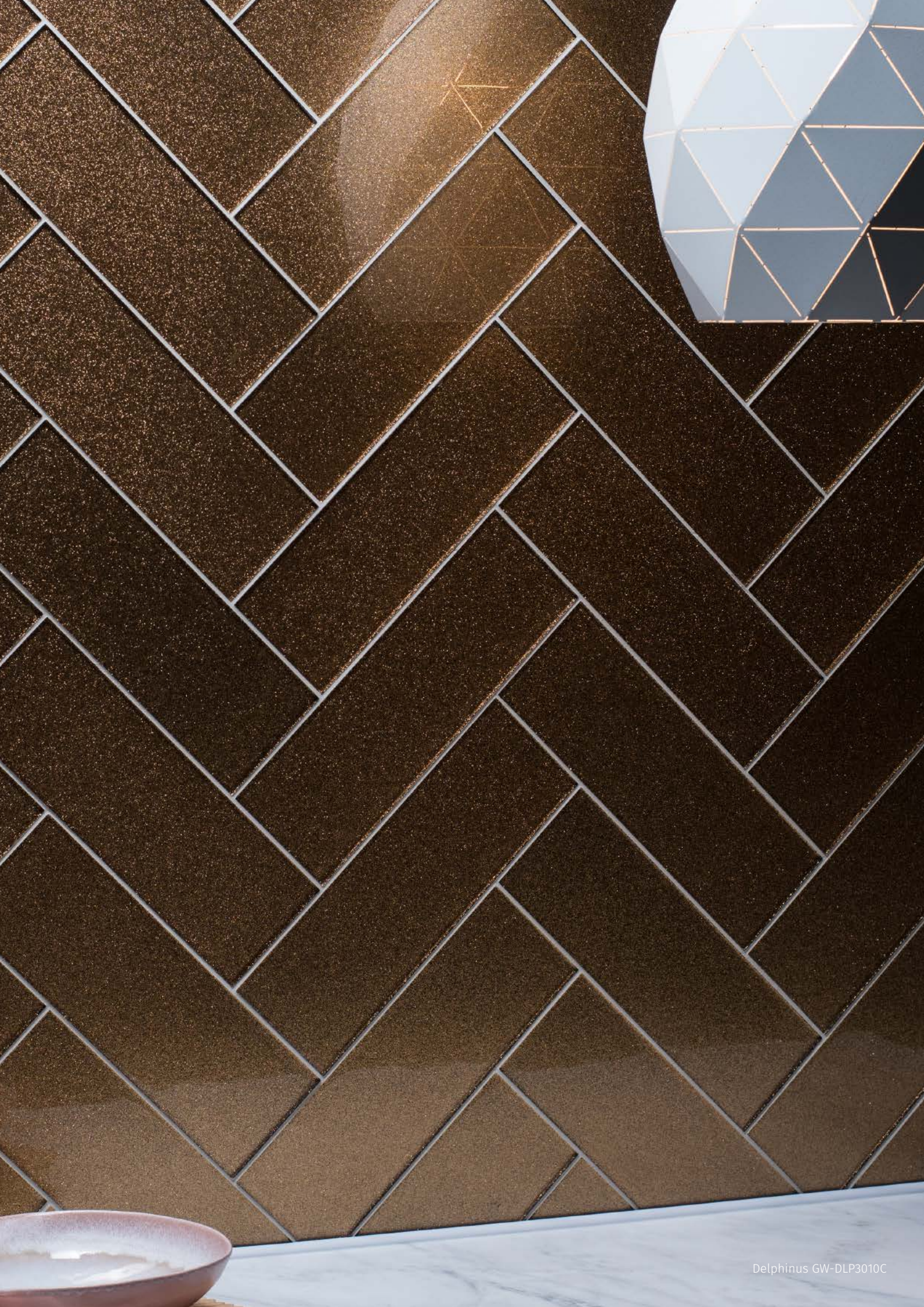





Erebos GW-ERB1575CM

Shine on

Metallics work really well in both bathrooms and kitchens. The brick format is very versatile, so why not experiment with different tile layouts to ring the changes? See pages 88-89 for all the colours available.

46

DECORATIVE
CAST GLASS

Burnished beauty

Bold textures and a mix of burnished metallic hues from dark to bright, in a versatile brick mosaic in three colour options.



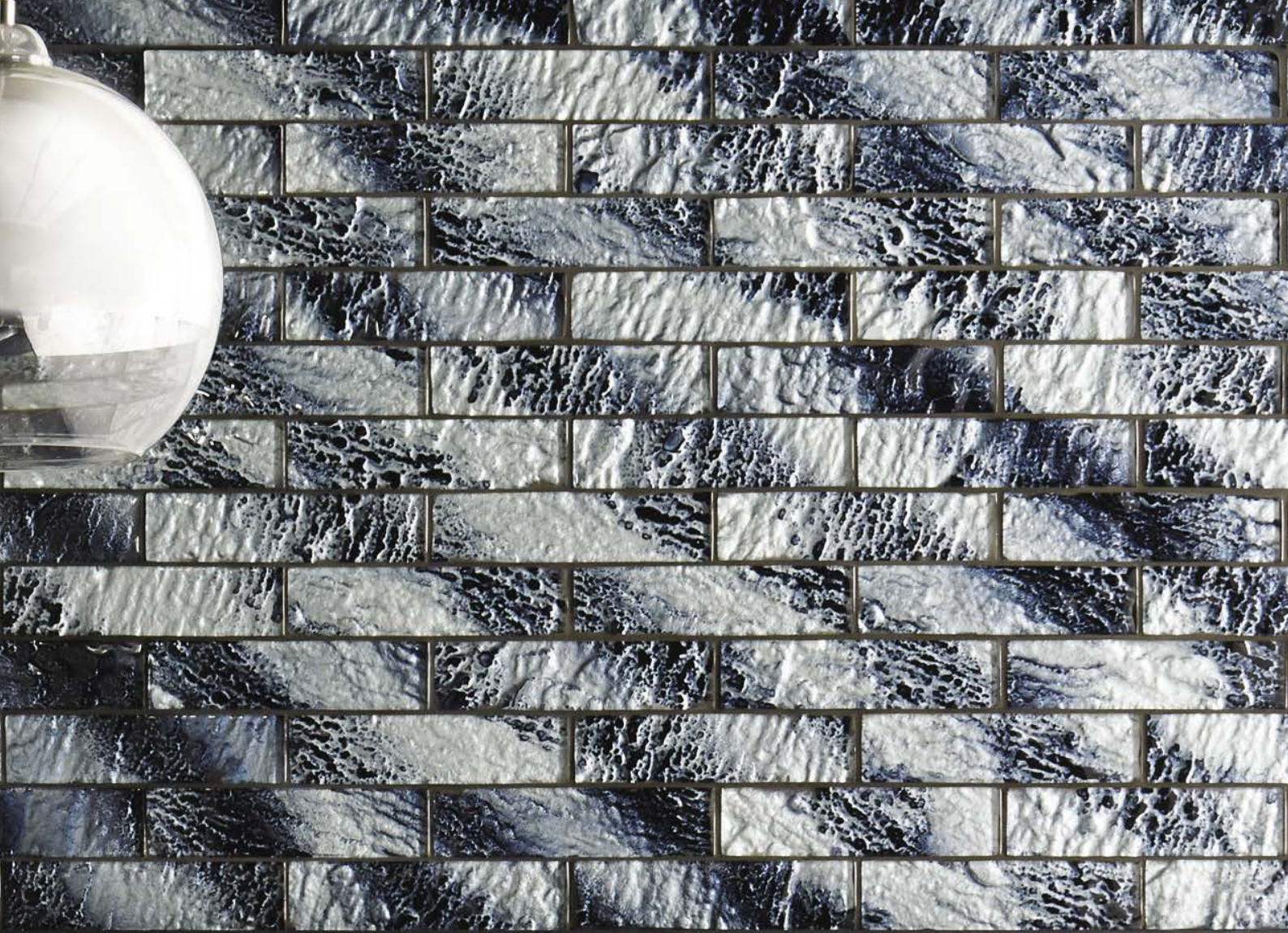

48

DECORATIVE
MOSAICS



Solinda Hexagon Mosaic GW-SONHEXMOS

Natural living

The hexagon – invented by nature and also looking very much at home on walls. Get on-trend with this honeycomb shaped mosaic which comes in five metallic colours. See page 57 for textured Hexagon options.





Hera Hexagon Mosaic GW-HERHEXMOS shown with Downtown White porcelain tiles from the Tileworks Collection





Futura Zircona Hexagon GW-FZHMOS

A different dimension

Treat your walls to exciting shape and texture
– hexagonal mosaics with a crocodile effect pattern.
See page 57 for details.





Metallic Effect

Colours available:

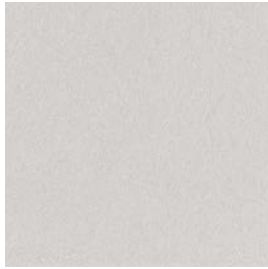

Solinda



Zinc



Dionysus



Starcia



Hypnos

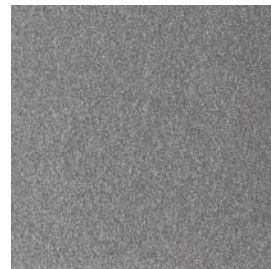

Erebos

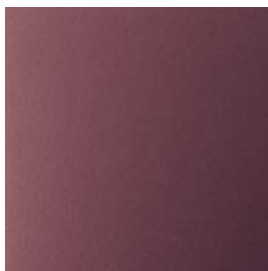

Ulysses



Mira



Hera



The swatches shown above are for reference only.
A number of different formats are available, please see pages 88-89 for availability.

Metallica

Please refer to the chart on pages 88-89 for product codes and sizes available



Triton



Galatea



Proteus



Ganymede



Thebe



Hermes



Hyperion



Titania



Please note, because of their size, these tiles are not in proportion to reference images of tiles in other sections.
 Merci de noter qu'en raison de leur taille ces carreaux ne sont pas en proportion avec les autres images dans les autres sections.
 Es ist zu merken, daß diese Fliesen in keinem Verhältniss zu der Abbildungen von Fliesen in anderer Ausschnitten stehen.
 De tegels in deze afbeeldingen zijn niet afgebeeld in dezelfde schaal als de tegels afgebeeld in andere secties.
 Обратите внимание, что из-за их размера эти плитки не соответствуют ссылочным изображениям плиток в других разделах.

Merci de vous rendre à la page 58 pour les codes produits et formats disponibles.
 Bitte wenden Sie Sich an den Graph auf Seite 58, um erhältlich Produktkennzeichen und Formate zu sehen.
 Gelieve te verwijzen naar het overzicht op bladzijde 58 voor product codes en beschikbare maten.
 Пожалуйста, обратитесь к таблице на страницах 58 для получения информации по кодам продуктов и доступных размеров

Constellation

Please refer to the chart on pages 88-89 for product codes and sizes available.



Perseus

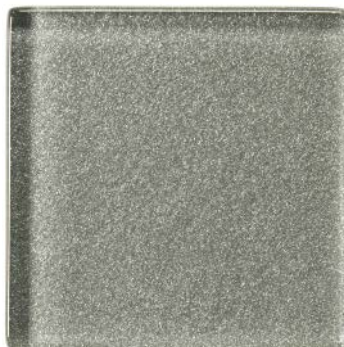

Hydrus



Andia



Lepus

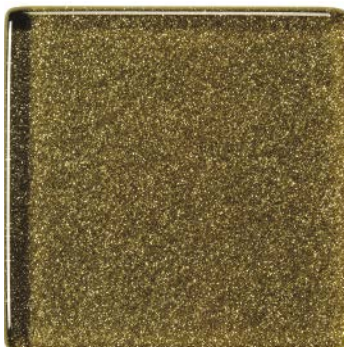

Delphinus



Aquila

Sparkling Effect



Argent



Meteor



Merci de vous rendre à la page 88 pour les codes produits et formats disponibles.

Bitte wenden Sie sich an den Graph auf Seite 88, um erhältliche Produktkennzeichen und Formate zu sehen.

Gelieve te verwijzen naar het overzicht op bladzijde 88 voor product codes en beschikbare maten.

Пожалуйста, обратитесь к таблице на страницах 88 для получения информации по кодам продуктов и доступных размеров

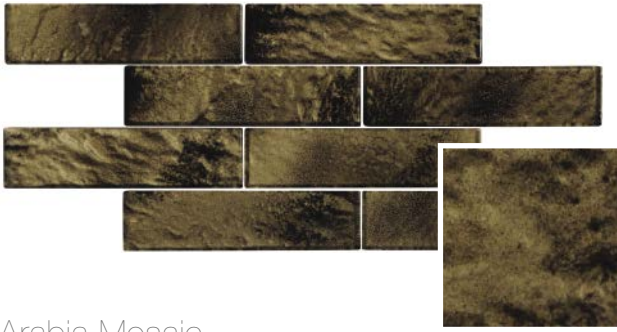

Arabia Mosaic

GW-ABAMOS

402 x 205 x 8mm (8 $\frac{1}{16}$ " x 15 $\frac{3}{16}$ " x $\frac{5}{16}$ ")

Mosaic with an undulating surface for added interest

Also available in a 600 x 300mm (11 $\frac{3}{16}$ " x 23 $\frac{5}{8}$ ") format see page 29

These tiles and mosaics are painted by hand and so each individual tile will be unique.
Ces carreaux et mosaïques sont peints à la main ; de ce fait chaque carreau sera unique.
ie Rückseiten dieser Fliesen und Mosaïke sind handbemalt und jede Fliese ist einzigartig.
Doordat de achterkant van deze glazen tegels en mozaïeken met de hand geschilderd zijn,
is iedere tegel uniek.
Обратная сторона этой плитки раскрашена вручную и поэтому каждая индивидуальная плитка уникальна.

Arabia Mosaic GW-ABAMOS
Ammon Mosaic GW-AMMMOS
Siva Mosaic GW-SIVMOS

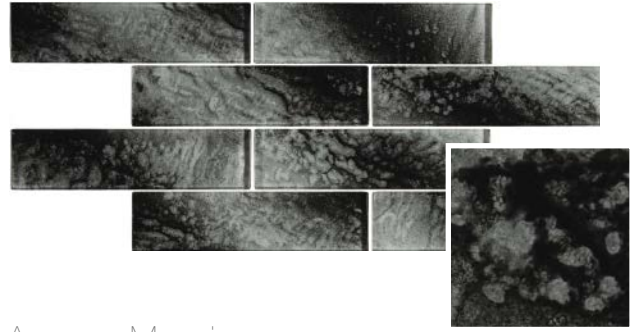

Ammon Mosaic

GW-AMMMOS

402 x 205 x 8mm (8 $\frac{1}{16}$ " x 15 $\frac{3}{16}$ " x $\frac{5}{16}$ ")

Mosaic with an undulating surface for added interest

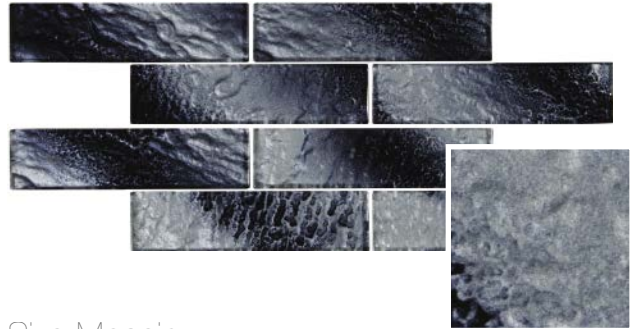

Siva Mosaic

GW-SIVMOS

402 x 205 x 8mm (8 $\frac{1}{16}$ " x 15 $\frac{3}{16}$ " x $\frac{5}{16}$ ")

Mosaic with an undulating surface for added interest



new!

Silver Leaf Facet Mosaic

GW-SLFMOSFM

300 x 300 x 8mm (11 $\frac{3}{16}$ " x 11 $\frac{3}{16}$ " x $\frac{5}{16}$ ")
50mm (2") pieces

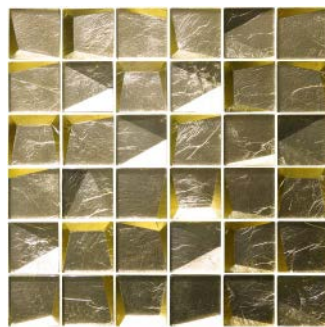

new!

Gold Leaf Facet Mosaic

GW-GLFMOSFM

300 x 300 x 8mm (11 $\frac{3}{16}$ " x 11 $\frac{3}{16}$ " x $\frac{5}{16}$ ")
50mm (2") pieces





Futura Sepia
Hexagon Mosaic

GW-FSHMOS

7 tiles per sheet (with 1mm grout gap)
Croc effect in a mix of sepia tones

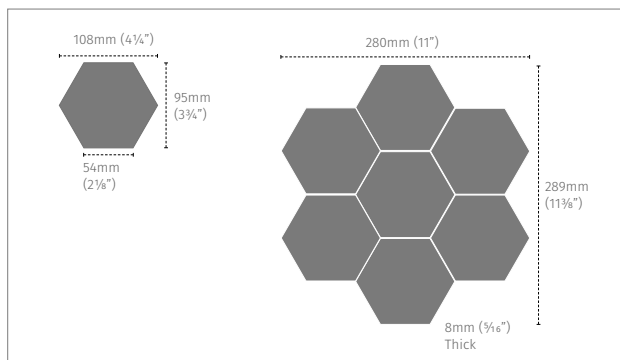

Futura Zirconia
Hexagon Mosaic

GW-FZHMOS

7 tiles per sheet (with 1mm grout gap)
Croc effect in a mix of grey tones

These tiles and mosaics are painted by hand and so each individual tile will be unique.
Ces carreaux et mosaïques sont peints à la main ; de ce fait chaque carreau sera unique.
Die Rückseiten dieser Fliesen und Mosaiken sind handbemalt und jede Fliese ist einzigartig.
Doordat de achterkant van deze glazen tegels en mozaïeken met de hand geschilderd zijn, is iedere tegel uniek.

Обратная сторона этой плитки раскрашена вручную и поэтому каждая индивидуальная плитка уникальна.

Futura Dichroic Hexagon Mosaic GW-FGHMOS
Futura Sepia Hexagon Mosaic GW-FSHMOS
Futura Zirconia Hexagon Mosaic GW-FZHMOS



Futura Dichroic
Hexagon Mosaic

GW-FGHMOS

7 tiles per sheet (with 1mm grout gap)
Changing tones of silvers and greys

A modern bathroom interior featuring a white bathtub in the foreground. The wall is covered in large, dark grey mirror tiles that reflect the surrounding environment, including a white bathtub in the background. Two black, teardrop-shaped pendant lights with a faceted, crystal-like base hang from the ceiling. To the left, a framed picture of a tree is mounted on a dark grey wall. A small round table with a white top and gold legs holds a white vase with greenery and a gold soap dish. A dark blue towel is draped over the edge of the bathtub.

Mirror tiles and mosaics

59

DECORATIVE
MIRROR



Antique Mirror White GW-ANTWHT6030



Antique Mirror Grey GW-ANTGR3010



Antique Mirror Bevel GW-ANT2010B

The wow factor

new
designs
added

Mirror tiles – There are antique effects, large formats, bevelled bricks and faceted mosaics for different moods. Radiate light around a room with Silver Mirror or create chic boudoir-style with smoky Antique Grey. See pages 62-65 for the complete range.

60

DECORATIVE
MIRROR



Antique Mirror Copper GW-ANT3010 shown with Sands Myrtos from the Tileworks collection



Antique Mirror Bevel GW-ANT2010B



Antique Mirror White



600 x 300mm

GW-ANTWH6030

600 x 300 x 6mm (11³/₁₆" x 23⁵/₈" x 1/4")

new!

Bevelled Brick

GW-ANTWH2008B

200 x 75 x 8mm (3" x 7⁷/₈" x 5/16")

300mm Brick

GW-ANTWH3010

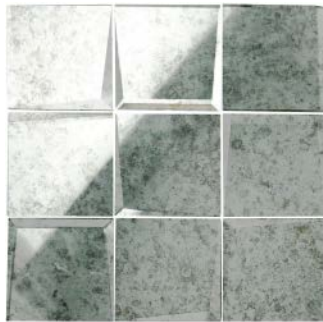
300 x 100 x 6mm (4" x 11³/₁₆" x 1/4")

new!

100mm Facet Mosaic

GW-ANTWHLMOS

305 x 305 x 5mm (12" x 12" x 1/4")
100mm (4") pieces

new!

50mm Facet Mosaic

GW-ANTWHMMOS

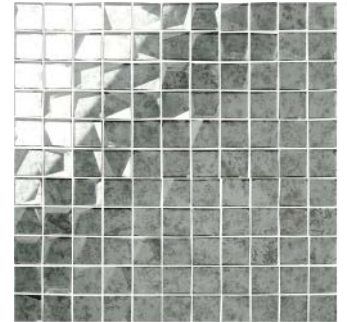
310 x 310 x 5mm 12³/₁₆" x 12³/₁₆" x 1/4")
50mm (2") pieces

new!

24mm Facet Mosaic

GW-ANTWHSMOS

295 x 295 x 5mm (11⁵/₈" x 11⁵/₈" x 1/4")
24mm (1") pieces

Antique Mirror Copper



300mm Brick

GW-ANTCP3010

300 x 100 x 6mm (4" x 11³/₁₆" x 1/4")

new!

600 x 300mm

GW-ANTCP6030

600 x 300 x 6mm (11³/₁₆" x 23⁵/₈" x 1/4")

Please note, because of their size, these tiles are not in proportion to reference images of tiles in other sections.
 Merci de noter qu'en raison de leur taille ces carreaux ne sont pas en proportion avec les autres images dans les autres sections.
 Es ist zu merken, daß diese Fliesen in keinem Verhältniss zu der Abbildungen von Fliesen in anderer Ausschnitten stehen.
 De tegels in deze afbeeldingen zijn niet afgebeeld in dezelfde schaal als de tegels afgebeeld in andere secties.
 Обратите внимание, что из-за их размера эти плитки не соответствуют ссылочным изображениям плиток в других разделах.

Antique Mirror Grey



new!

600 x 300mm

GW-ANTGR6030

600 x 300 x 6mm (11³/₁₆" x 23⁵/₈" x 1/4")



new!

Bevelled Brick

GW-ANTGR2008B

200 x 75 x 8mm (3" x 7⁷/₈" x 5/16")



300mm Brick

GW-ANTGR3010

300 x 100 x 6mm (4" x 11³/₁₆" x 1/4")



new!

100mm Facet Mosaic

GW-ANTGRMOS

305 x 305 x 5mm (12" x 12" x 1/4")
100mm (4") pieces

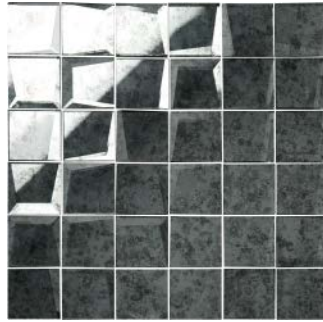

new!

50mm Facet Mosaic

GW-ANTGRMMOS

310 x 310 x 5mm 12³/₁₆" x 12³/₁₆" x 1/4")
50mm (2") pieces

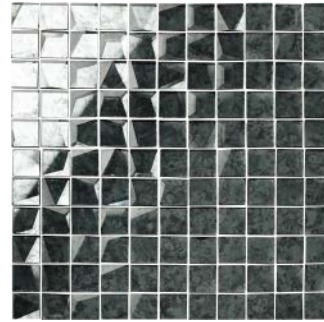

new!

24mm Facet Mosaic

GW-ANTGRSMOS

295 x 295 x 5mm (11⁵/₈" x 11⁵/₈" x 1/4")
24mm (1") pieces



new!

100mm Facet Mosaic

GW-ANTCPLMOS

305 x 305 x 5mm (12" x 12" x 1/4")
100mm (4") pieces

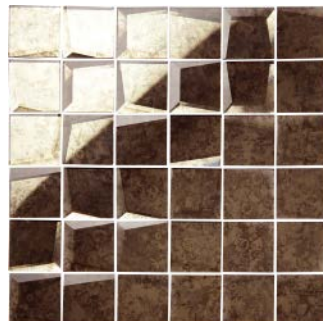

new!

50mm Facet Mosaic

GW-ANTCPMMOS

310 x 310 x 5mm 12³/₁₆" x 12³/₁₆" x 1/4")
50mm (2") pieces

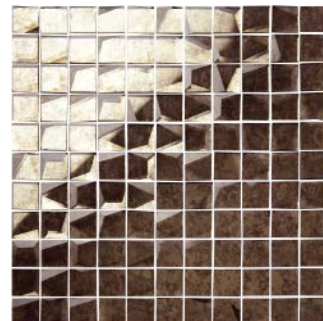

new!

24mm Facet Mosaic

GW-ANTCPSMOS

295 x 295 x 5mm (11⁵/₈" x 11⁵/₈" x 1/4")
24mm (1") pieces





Silver Mirror



new!

100mm Facet Mosaic

GW-SMRLMOS
305 x 305 x 5mm (12" x 12" x 1/4")
100mm (4") pieces



new!

50mm Facet Mosaic

GW-SMRMMOS
310 x 310 x 5mm (12 3/16" x 12 3/16" x 1/4")
50mm (2") pieces



new!

24mm Facet Mosaic

GW-SMRSMOS
295 x 295 x 5mm (11 5/8" x 11 5/8" x 1/4")
24mm (1") pieces



Mirror Bevel

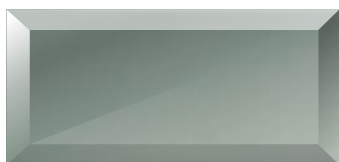

Silver Mirror Bevel

GW-SMR2010B
200 x 100 x 8mm (8" x 4" x 5/16")

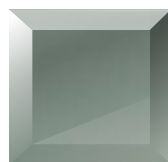
Silver Mirror Bevel
Finishing Piece

GW-SMR1010B
100 x 100 x 8mm (4" x 4" x 5/16")



Antique Mirror Bevel

GW-ANT2010B
200 x 100 x 5mm (8" x 4" x 1/8")

Antique Mirror Bevel
Finishing Piece

GW-ANT1010B
100 x 100 x 5mm (4" x 4" x 1/8")



Please note, because of their size, these tiles are not in proportion to reference images of tiles in other sections.
 Merci de noter qu'en raison de leur taille ces carreaux ne sont pas en proportion avec les autres images dans les autres sections.
 Es ist zu merken, daß diese Fliesen in keinem Verhältnis zu der Abbildungen von Fliesen in anderer Ausschnitten stehen.
 De tegels in deze afbeeldingen zijn niet afgebeeld in dezelfde schaal als de tegels afgebeeld in andere secties.
 Обратите внимание, что из-за их размера эти плитки не соответствуют ссылочным изображениям плиток в других разделах.

66

SPLASHBACKS
AND UPSTANDS

Splashbacks & upstands





Aurora Borealis Aqua GW-AQA3606C



Perfume Splashback GW-PFM2406C

Big is beautiful

Our large panel Splashbacks are made from heat-resistant toughened glass, which is perfectly safe for use behind cooking hobs (close to sources of heat), but there's no need to stop there. You can enjoy the translucent beauty of this versatile material on interior walls such as kitchens, dining areas, living rooms and bathrooms throughout your home – and it is tough enough for commercial wall settings as well. Splashbacks are quick and simple to install, and it's easy to keep them sparkling clean and beautifully shiny.

Take colour co-ordination to another level, and install splashbacks in a bedroom and its en-suite bathroom. Use similar colours throughout to create a cool and relaxing zone. Achieve a stylish, modern look by placing glass alongside materials with matt surfaces such as slate and wood.

elegant style for
Areas of glossy colour in



Wall behind chair Zinc Splashbacks GW-ZIN3606C,
and Upstands GW-ZIN10014C placed vertically on front of
the pillar. Floor is Illusion White from the Tileworks Collection

Thames Splashbacks GW-THA2406C shown
with Graphite Black Slate from the Earthworks collection

kitchens, bedrooms & bathrooms
calm, understated shades



70

SPLASHBACKS



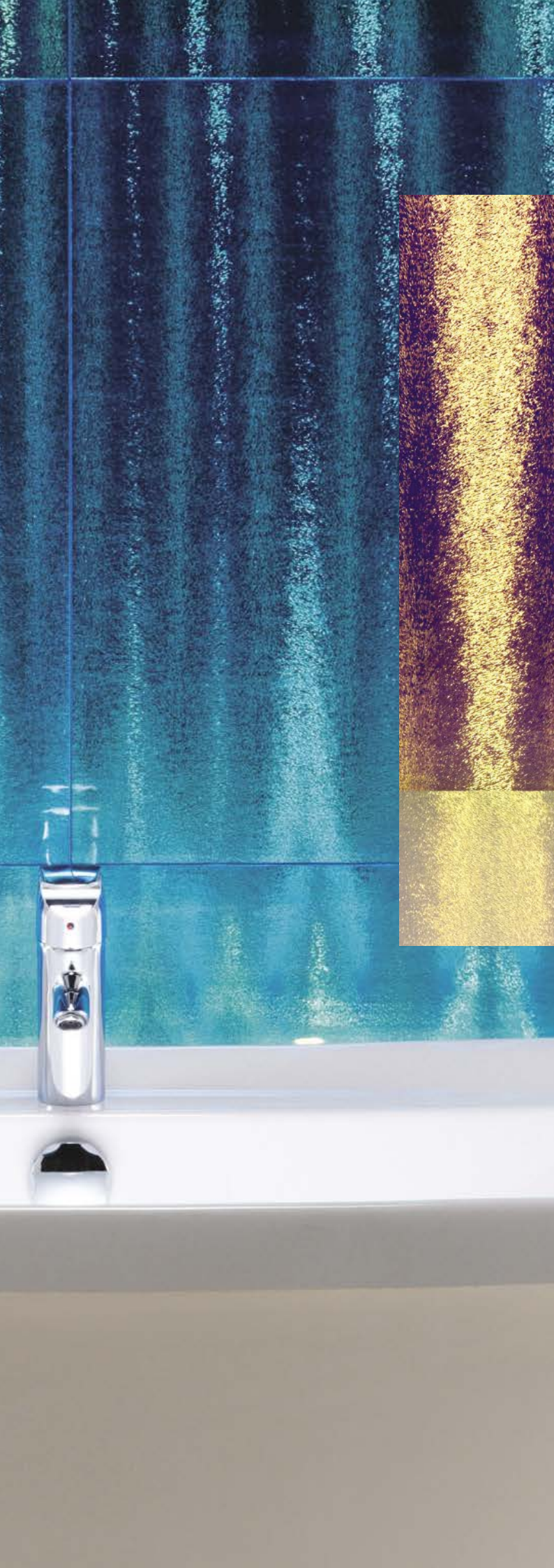

Aurora Borealis Aura

Introducing some serious colour and shine!

This unique rainbow effect is available in three colour ways. Install these and you will never tire of the amazing effects that will appear from different viewpoints, and by using various types of lighting.

solid colours



Arctic

GW-ART2406C 600 x 750 x 6mm (29½" x 23⅝" x ⅜")
 GW-ART3606C 900 x 750 x 6mm (29½" x 35⅞" x ⅜")

Upstand: GW-ART10014C 1000 x 140 x 6mm (5½" x 39⅜" x ⅜")



Volga

GW-VOL2406C 600 x 750 x 6mm (29½" x 23⅝" x ⅜")
 GW-VOL3606C 900 x 750 x 6mm (29½" x 35⅞" x ⅜")

Upstand: GW-VOL10014C 1000 x 140 x 6mm (5½" x 39⅜" x ⅜")



Thames

GW-THA2406C 600 x 750 x 6mm (29½" x 23⅝" x ⅜")
 GW-THA3606C 900 x 750 x 6mm (29½" x 35⅞" x ⅜")

Upstand: GW-THA10014C 1000 x 140 x 6mm (5½" x 39⅜" x ⅜")



Avon

GW-AVO2406C 600 x 750 x 6mm (29½" x 23⅝" x ⅜")
 GW-AVO3606C 900 x 750 x 6mm (29½" x 35⅞" x ⅜")

Upstand: GW-AVO10014C 1000 x 140 x 6mm (5½" x 39⅜" x ⅜")



Perfume

GW-PFM2406C 600 x 750 x 6mm (29½" x 23⅝" x ⅜")
 GW-PFM3606C 900 x 750 x 6mm (29½" x 35⅞" x ⅜")

Upstand: GW-PFM10014C 1000 x 140 x 6mm (5½" x 39⅜" x ⅜")



Mekong

GW-MEK2406C 600 x 750 x 6mm (29½" x 23⅝" x ⅜")
 GW-MEK3606C 900 x 750 x 6mm (29½" x 35⅞" x ⅜")

Upstand: GW-MEK10014C 1000 x 140 x 6mm (5½" x 39⅜" x ⅜")



Mississippi

GW-MSP2406C 600 x 750 x 6mm (29½" x 23⅝" x ⅜")
 GW-MSP3606C 900 x 750 x 6mm (29½" x 35⅞" x ⅜")

Upstand: GW-MSP10014C 1000 x 140 x 6mm (5½" x 39⅜" x ⅜")



Mohaka

GW-MOH2406C 600 x 750 x 6mm (29½" x 23⅝" x ⅜")
 GW-MOH3606C 900 x 750 x 6mm (29½" x 35⅞" x ⅜")

Upstand: GW-MOH10014C 1000 x 140 x 6mm (5½" x 39⅜" x ⅜")



Indus

GW-IND2406C 600 x 750 x 6mm (29½" x 23⅝" x ⅜")
 GW-IND3606C 900 x 750 x 6mm (29½" x 35⅞" x ⅜")

Upstand: GW-IND10014C 1000 x 140 x 6mm (5½" x 39⅜" x ⅜")

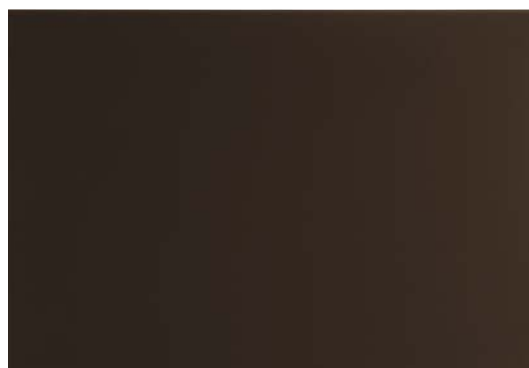

Chenab

GW-CHB2406C 600 x 750 x 6mm (29½" x 23⅝" x ⅜")
 GW-CHB3606C 900 x 750 x 6mm (29½" x 35⅞" x ⅜")

Upstand: GW-CHB10014C 1000 x 140 x 6mm (5½" x 39⅜" x ⅜")



Ebro

GW-EBO2406C 600 x 750 x 6mm (29½" x 23⅝" x ⅜")
 GW-EBO3606C 900 x 750 x 6mm (29½" x 35⅞" x ⅜")

Upstand: GW-EBO10014C 1000 x 140 x 6mm (5½" x 39⅜" x ⅜")

Ebro



sparkling effect

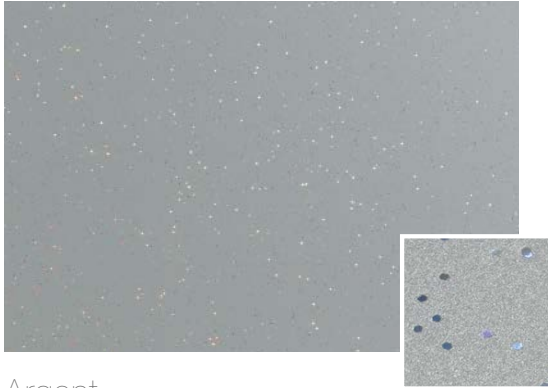

Argent

GW-AGT2406C 600 x 750 x 6mm (29½" x 23⅝" x ⅜")
 GW-AGT3606C 900 x 750 x 6mm (29½" x 35⅞" x ⅜")

Upstand: GW-AGT10014C 1000 x 140 x 6mm (5½" x 39⅜" x ⅜")

rainbow effect

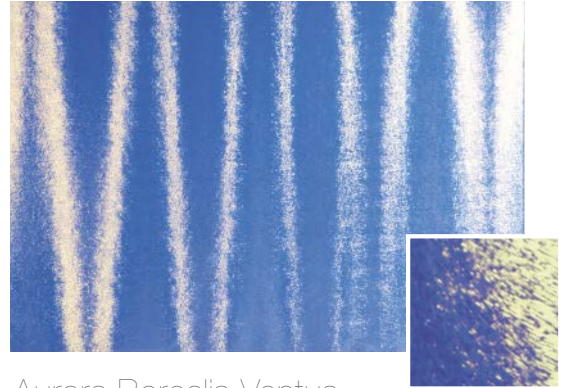

Aurora Borealis Ventus

GW-VEN2406C 600 x 750 x 6mm (29½" x 23⅝" x ⅜")
 GW-VEN3606C 900 x 750 x 6mm (29½" x 35⅞" x ⅜")



Perse

GW-PRS2406C 600 x 750 x 6mm (29½" x 23⅝" x ⅜")
 GW-PRS3606C 900 x 750 x 6mm (29½" x 35⅞" x ⅜")

Upstand: GW-PRS10014C 1000 x 140 x 6mm (5½" x 39⅜" x ⅜")

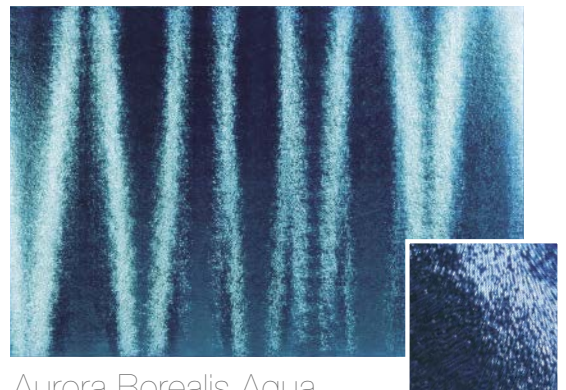

Aurora Borealis Aqua

GW-AQA2406C 600 x 750 x 6mm (29½" x 23⅝" x ⅜")
 GW-AQA3606C 900 x 750 x 6mm (29½" x 35⅞" x ⅜")

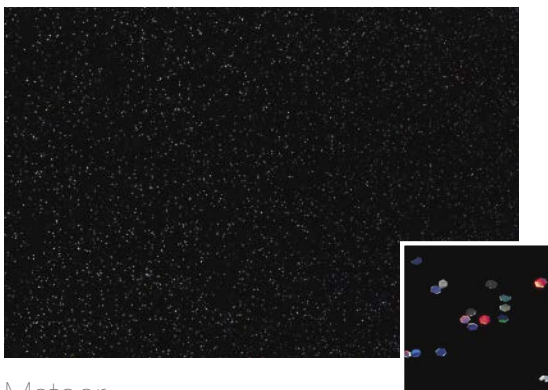

Meteor

GW-MET2406C 600 x 750 x 6mm (29½" x 23⅝" x ⅜")
 GW-MET3606C 900 x 750 x 6mm (29½" x 35⅞" x ⅜")

Upstand: GW-MET10014C 1000 x 140 x 6mm (5½" x 39⅜" x ⅜")

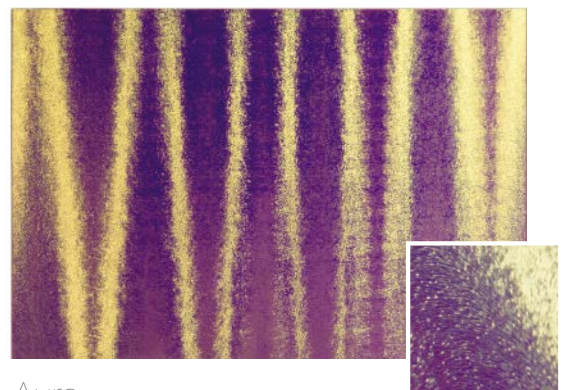

Aura

GW-AUR2406C 600 x 750 x 6mm (29½" x 23⅝" x ⅜")
 GW-AUR3606C 900 x 750 x 6mm (29½" x 35⅞" x ⅜")

metallic effect



Champagne

GW-CHA2406C 600 x 750 x 6mm (29½" x 23⅝" x ⅜")

GW-CHA3606C 900 x 750 x 6mm (29½" x 35⅞" x ⅜")

Upstand: GW-CHA10014C 1000 x 140 x 6mm (5½" x 39⅜" x ⅜")

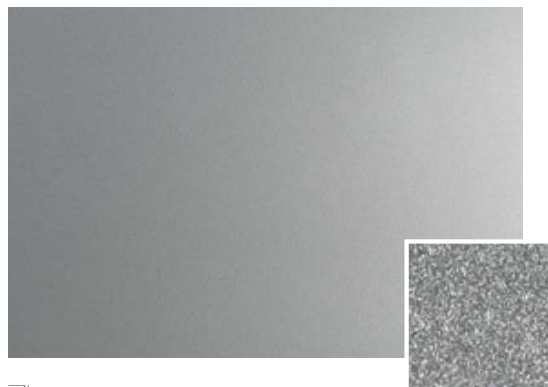

Zinc

GW-ZIN2406C 600 x 750 x 6mm (29½" x 23⅝" x ⅜")

GW-ZIN3606C 900 x 750 x 6mm (29½" x 35⅞" x ⅜")

Upstand: GW-ZIN10014C 1000 x 140 x 6mm (5½" x 39⅜" x ⅜")

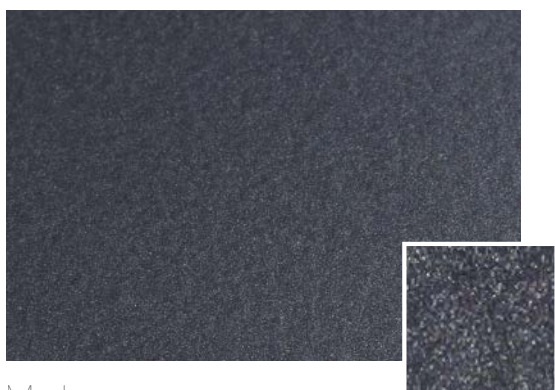

Merle

GW-MRL2406C 600 x 750 x 6mm (29½" x 23⅝" x ⅜")

GW-MRL3606C 900 x 750 x 6mm (29½" x 35⅞" x ⅜")

Upstand: GW-MRL10014C 1000 x 140 x 6mm (5½" x 39⅜" x ⅜")

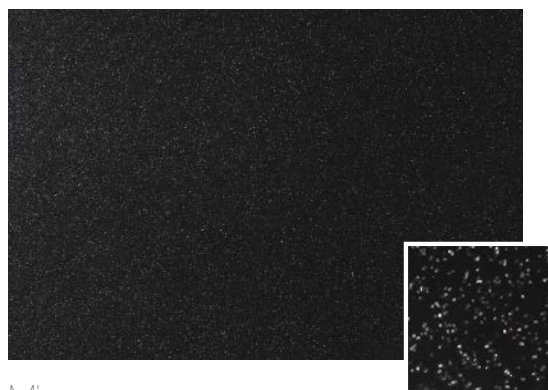

Mira

GW-MIR2406C 600 x 750 x 6mm (29½" x 23⅝" x ⅜")

GW-MIR3606C 900 x 750 x 6mm (29½" x 35⅞" x ⅜")

Upstand: GW-MIR10014C 1000 x 140 x 6mm (5½" x 39⅜" x ⅜")

Aurora Borealis Splashback Patterns

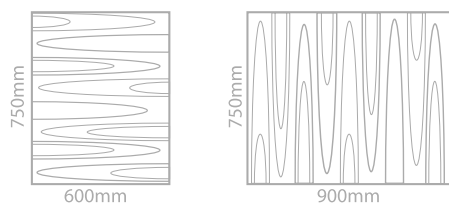

Because of the way they are made, every Aurora Borealis tile is unique. When they are placed together the patterns will not necessarily match each other but the overall effect will be stunning.

*NB Splashbacks must NOT be cut. Please see Important Information section.

*NB Les Splashbacks ne doivent JAMAIS être découpés. Veuillez vous reporter aux Informations Essentielles.

*Hinweis: Splashbacks dürfen NICHT geschnitten werden. Bitte lesen Sie den Abschnitt "Wichtige Informationen".

*Let op: Splashbacks mogen NIET gesneden worden. Raadpleeg alstublieft onze Belangrijke Informatie.

*NB Splashbacks нельзя резать! См. Раздел «Важная информация».



Zinc

76

CLEAR AND
FROSTED

Glass is beautiful — and also practical, making it a perfect material for many different locations. Be inspired by these settings: there's no reason not to use glass tiles in a bedroom, hallway, living room or dining area. They are easy to keep clean and glass always stays looking good. With the range of sizes and colours available you will be spoilt for choice. You can coordinate them with mosaics, stone and porcelain too.

Clear &



Chenab Clear GW-CHB3010C shown with Shadow Ice porcelain tiles on the wall behind the bed and Broadway Lime Porcelain floor tiles, both from the Tileworks Collection, and in the en suite, Cascade Silk mosaics from the Mosaics Collection



frosted

Choose from a range of different sizes in clear and frosted colours

In the next few pages you'll find wall tiles in sizes ranging from 48 x 48mm / 1⁷/₈" x 1⁷/₈" to splashbacks of 900 x 750mm / 23⁵/₈" x 35³/₈", in a wide range of colours in both shining clear and frosted finishes.

A vibrant red, modern armchair with a chrome base, set against a dark grey tiled wall. The chair has a sleek, curved design with a high back and a wide seat. The background is a wall of dark grey, rectangular tiles with a glossy finish. The floor is a light, neutral color. The overall aesthetic is contemporary and minimalist.

Be brave and
experiment with
different sizes and
colours to achieve
the look you desire

Mekong GW-MEK6030C with Mineral Grafite Polished porcelain floor tiles from the Tileworks Collection



Avon clear tiles (398 x 80mm / 31 $\frac{1}{8}$ " X 15 $\frac{3}{4}$ ") have been placed horizontally for a modern style with clean lines in the image shown left. Large format tiles in Mekong red (see above) have been combined with black and grey. Red is often used by interior designers for dining rooms (in homes, restaurants and pubs) as it promotes feelings of energy and warmth, encourages people to be sociable and even stimulates the appetite!

Avon GW-AV01636C with Mineral Off White Structured Porcelain floor tiles from the Tileworks Collection

80

CLEAR AND
FROSTED

Add another dimension to your walls with a bevel

Bevelled tiles (shown right) provide extra surfaces for light and reflection to come into play and look beautiful wherever they are placed. We have bevel tiles and finishing half tiles in 11 clear colours and four metallic/sparkling colours for you to choose from.

Living spaces can look stunning with a glossy, reflective expanse of colour as a feature wall (below). Here we've used Splashbacks for maximum coverage, with upstands running along the lower edge as a skirting.



Ebro Splashback GW-EBO3606C and Upstand GW-EBO10014C

NOTE: Bevel tiles can be used in a brickbond pattern as shown here, and there is also a half size bevel tile to ensure neat edges and minimal cutting. Turn to page 52 to see bevel tiles installed in straight lines, and see pages 90-91 for the colours available.





82

CLEAR AND
FROSTED



Colorado GW-COR6030C



Colorado Bevelled GW-COR2010B

Clean lines and clever colours for your kitchen

Choosing the right tiles for your kitchen is like selecting ingredients for the perfect recipe – get all the components right and you'll get an amazing end result.





For the opposite of shiny or to lend softness to a surface, the tactile qualities of tiles with a frosted finish are perfect.

They come in two sizes (100 x 100mm / 4" x 4" and 398 x 80mm / 31/8" x 153/4") and in colours that co-ordinate and contrast with most of the tiles with a clear finish.

Turn the page for more information on all the colours and sizes available in both Clear and Frosted formats.

clear glass

Please refer to the chart on pages 90-91 for product codes and sizes available.



Volga



Columbia



Mississippi



Zambezi



Arkansas



Amazon



Mohaka



Nile



Seine



Loire



Colorado



Missouri



Bosphorus



Moselle



Danube



Rhine



Please note, because of their size, these tiles are not in proportion to reference images of tiles in other sections.
 Merci de noter qu'en raison de leur taille ces carreaux ne sont pas en proportion avec les autres images dans les autres sections.
 Es ist zu merken, daß diese Fliesen in keinem Verhältniss zu der Abbildungen von Fliesen in anderer Ausschnitten stehen.
 De tegels in deze afbeeldingen zijn niet afgebeeld in dezelfde schaal als de tegels afgebeeld in andere secties.
 Обратите внимание, что из-за их размера эти плитки не соответствуют ссылочным изображениям плиток в других разделах.



Arctic



Thames



Avon



Indus



Yukon



Murray



Sala



Chenab



Mekong



Ebro



Rio Grande



Tigris



Perfume



Mackenzie



Orinoco



Merci de vous rendre à la page 90-91 pour les codes produits et formats disponibles.

Bitte wenden Sie sich an den Graph auf Seite 90-91, um erhältliche Produktkennzeichen und Formate zu sehen.

Gelieve te verwijzen naar het overzicht op bladzijde 90-91 voor product codes en beschikbare maten.

Пожалуйста, обратитесь к таблице на страницах 90-91 для получения информации по кодам продуктов и доступных размеров

frosted glass

Please refer to the chart on pages 92 for product codes and sizes available.



Arctic



Volga



Yukon



Thames



Amazon



Nile



Columbia



Mississippi



Seine



Colorado



Missouri



Zambezi



Loire



Danube



Rhine



Murray



Orinoco



Merci de vous rendre à la page 92 pour les codes produits et formats disponibles.

Bitte wenden Sie sich an den Graph auf Seite 92, um erhältliche Produktkennzeichen und Formate zu sehen.

Gelieve te verwijzen naar het overzicht op bladzijde 92 voor product codes en beschikbare maten.

Пожалуйста, обратитесь к таблице на страницах 92 для получения информации по кодам продуктов и доступных размеров

clear highlight strips

Use them singly or blend combinations together. They look great whether they are placed horizontally or vertically.



Mackenzie GW-MACLFB
298 x 23.5 x 8mm (1⁵/₁₆ x 11³/₄ x 5/₁₆"



Mekong GW-MEKLFB
298 x 23.5 x 8mm (1⁵/₁₆ x 11³/₄ x 5/₁₆"



Tigris GW-TIGLFB
298 x 23.5 x 8mm (1⁵/₁₆ x 11³/₄ x 5/₁₆"



Thames GW-THALFB
298 x 23.5 x 8mm (1⁵/₁₆ x 11³/₄ x 5/₁₆"



Avon GW-AVOLFB
298 x 23.5 x 8mm (1⁵/₁₆ x 11³/₄ x 5/₁₆"



Indus GW-INDLFB
298 x 23.5 x 8mm (1⁵/₁₆ x 11³/₄ x 5/₁₆"



Arctic GW-ARTLFB
298 x 23.5 x 8mm (1⁵/₁₆ x 11³/₄ x 5/₁₆"



Volga GW-VOLLFB
298 x 23.5 x 8mm (1⁵/₁₆ x 11³/₄ x 5/₁₆"



Columbia GW-COLLFB
298 x 23.5 x 8mm (1⁵/₁₆ x 11³/₄ x 5/₁₆"



Mississippi GW-MSPLFB
298 x 23.5 x 8mm (1⁵/₁₆ x 11³/₄ x 5/₁₆"



Arkansas GW-ARKLFB
298 x 23.5 x 8mm (1⁵/₁₆ x 11³/₄ x 5/₁₆"



Danube GW-DANLFB
298 x 23.5 x 8mm (1⁵/₁₆ x 11³/₄ x 5/₁₆"

metallica strips

Classy metallic effect borders. Use with matching Metallica tiles or in contrast to Clear or Frosted finishes.



Galatea GW-GLTBDR
300 x 35 x 8mm (1¹/₈ x 11³/₄ x 5/₁₆"



Ganymede GW-GNYBDR
300 x 35 x 8mm (1¹/₈ x 11³/₄ x 5/₁₆"



Proteus GW-PROBDR
300 x 35 x 8mm (1¹/₈ x 11³/₄ x 5/₁₆"



Hermes GW-HRMBDR
300 x 35 x 8mm (1¹/₈ x 11³/₄ x 5/₁₆"



cyclades borders

Subtle and muted, these Cyclades borders will suit many styles of interior. Use them horizontally or vertically.



Kimolos GW-KMLSBS shown with Byzantine Bronze natural stone from the Earthworks collection



Kimolos GW-KMLSBS
300 x 48 x 8mm (1¹/₈ x 11³/₄ x 5/₁₆"



Milos GW-MILCSBL
300 x 48 x 8mm (1¹/₈ x 11³/₄ x 5/₁₆"



Ios GW-IOCSBL
300 x 48 x 8mm (1¹/₈ x 11³/₄ x 5/₁₆"



Santorini GW-SANCSBL
300 x 48 x 8mm (1¹/₈ x 11³/₄ x 5/₁₆"

Please note, because of their size, these tiles are not in proportion to reference images of tiles in other sections.
Merci de noter qu'en raison de leur taille ces carreaux ne sont pas en proportion avec les autres images dans les autres sections.
Es ist zu merken, daß diese Fliesen in keinem Verhältnis zu der Abbildungen von Fliesen in anderer Ausschnitten stehen.
De tegels in deze afbeeldingen zijn niet afgebeeld in dezelfde schaal als de tegels afgebeeld in andere secties.
Обратите внимание, что из-за их размера эти плитки не соответствуют ссылочным изображениям плиток в других разделах.





PRODUCT
REFERENCE

metallic, sparkling effect and mirrored glass tiles

Size (mm)	100 x 100 x 10	100 x 100 x 8 Bevel Finishing	200 x 100 x 8 Bevel	200 x 75 x 8 Bevel	150 x 75 x 10	152 x 75 x 6	300 x 100 x 6	600 x 300 x 6
Size (Inches)	4 x 4 x 3/8	4 x 4 x 5/16 Bevel Finishing	4 x 8 x 5/16 Bevel	3 x 7 7/8 x 5/16 Bevel	3 x 5 1/16 x 3/8	3 x 6 x 1/4	4 x 11 3/4 x 1/4	11 3/16 x 23 3/8 x 1/4
Shape (not to scale)								
Metallic Effect								
Hera	-	-	-	-	-	GW-HER1575CM	-	-
Erebos	-	-	-	-	-	GW-ERB1575CM	-	-
Hypnos	-	-	-	-	-	GW-HPS1575CM	-	-
Starcia	-	-	-	-	-	GW-SCI1575CM	-	-
Solinda	-	-	-	-	-	GW-SON1575CM	-	-
Champagne	-	-	-	-	-	-	-	-
Dionysus	-	GW-DIO1010B	GW-DIO2010B	-	-	GW-DIO1575CM	GW-DIO3010C	GW-DIO6030C
Zinc	-	GW-ZIN1010B	GW-ZIN2010B	-	-	-	GW-ZIN3010C	GW-ZIN6030C
Mira	-	GW-MIR1010B	GW-MIR2010B	-	-	-	GW-MIR3010C	GW-MIR6030C
Ulysses	-	GW-ULY1010B	GW-ULY2010B	-	-	-	GW-ULY3010C	-
Merle	-	-	-	-	-	-	-	-
Metallica								
Triton	GW-TRT410MFT	-	-	-	GW-TRT610SFT*	-	GW-TRT3010C	-
Galatea	GW-GLT410MFT	-	-	-	GW-GLT610SFT*	-	GW-GLT3010C	-
Proteus	GW-PRO410MFT	-	-	-	GW-PRO610SFT*	-	GW-PRO3010C	-
Titania	-	-	-	-	-	-	GW-TTA3010C	-
Ganymede	GW-GNY410MFT	-	-	-	GW-GNY610SFT*	-	-	-
Hermes	GW-HRM410MFT	-	-	-	GW-HRM610SFT*	-	GW-HRM3010C	-
Constellation								
Perseus	GW-PER410MF	-	-	-	-	-	-	-
Hydrus	GW-HYD410MF	-	-	-	-	-	GW-HYD3010C	-
Andia	GW-ADA410MF	-	-	-	-	-	-	-
Lepus	GW-LPS410MF	-	-	-	-	-	-	-
Delphinus	GW-DLP410MF	-	-	-	-	-	GW-DLP3010C	-
Aquila	GW-AQU410MF	-	-	-	-	-	-	-
Sparkling Effect								
Argent	-	-	-	-	-	-	GW-AGT3010C	GW-AGT6030C
Perse	-	-	-	-	-	-	-	-
Meteor	-	-	-	-	-	-	GW-MET3010C	GW-MET6030C
Mirror Effect								
Silver Mirror	-	GW-SMR1010B	GW-SMR2010B	-	-	-	-	-
Antique Mirror	-	GW-ANT1010B	GW-ANT2010B	-	-	-	-	-
Antique Mirror White	-	-	-	GW-ANTWH2008	-	-	GW-ANTWH3010	GW-ANTWH6030
Antique Mirror Grey	-	-	-	GW-ANTGR2008	-	-	GW-ANTGR3010	-
Antique Mirror Copper	-	-	-	-	-	-	GW-ANTCP3010	-

NEW PRODUCT

*Please note that the textured finish behind the glass of these tiles (codes 'SFT') is smoother than that of the Metallica tiles with codes 'MFT'.

*Veuillez noter que ces carreaux (code article suffixe SFT) ont une finition plus lisse par rapport aux carreaux précisés par le code article suffixe MFT.

*Anmerkung: Fliesen deren Artikelnummer in „SFT“ endet haben eine glattere Beschichtung als die Fliesen mit der Artikelnummer „MFT“.

*De getextureerde en gekleurde sublaag achter het glas van deze tegels (codes'SFT') is gladder dan die van de Metallica tegels met codes 'MFT'.







*Обратите внимание, что текстурированная отделка под стеклом данной плитки (с кодом SFT) более гладкая, чем у плитки Metallica с кодом MFT.

plain coloured glass

Size (mm)	48 x 48 x 10	100 x 100 x 10	152 x 50 x 6	200 x 98 x 6	300 x 100 x 6	398 x 80 x 6mm	398 x 198 x 6mm
Size (Inches)	1 ⁷ / ₈ x 1 ⁷ / ₈ x ³ / ₈	4 x 4 x ³ / ₈	2 x 6 x ¹ / ₄	4 x 8 x ¹ / ₄	4 x 11 ³ / ₄ x ¹ / ₄	3 ¹ / ₈ x 15 ³ / ₄ x ¹ / ₄	7 ⁷ / ₈ x 15 ³ / ₄ x ¹ / ₄
Shape (not to scale)							
Arctic	GW-ART210C	GW-ART410C	GW-ART656BC	GW-ART846C	GW-ART3010C	GW-ART1636C	GW-ART1606C
Volga	GW-VOL210C	GW-VOL410C	GW-VOL656BC	GW-VOL846C	GW-VOL3010C	GW-VOL1636C	GW-VOL1606C
Columbia	GW-COL210C	GW-COL410C	GW-COL656BC	GW-COL846C	-	-	-
Mississippi	GW-MSP210C	GW-MSP410C	-	GW-MSP846C	GW-MSP3010C	GW-MSP1636C	GW-MSP1606C
Arkansas	GW-ARK210C	GW-ARK410C	-	-	-	-	-
Amazon	GW-AMA210C	GW-AMA410C	-	-	-	-	-
Mohaka	-	-	-	-	GW-MOH3010C	-	-
Nile	GW-NIL210C	GW-NIL410C	-	-	-	-	-
Zambezi	GW-ZAM210C	GW-ZAM410C	GW-ZAM656BC	GW-ZAM846C	-	-	-
Colorado	GW-COR210C	GW-COR410C	-	-	GW-COR3010C	-	GW-COR1606C
Missouri	GW-MOR210C	GW-MOR410C	GW-MOR656BC	-	-	-	-
Seine	GW-SEN210C	GW-SEN410C	GW-SEN656BC	-	-	-	-
Loire	GW-LOR210C	GW-LOR410C	-	-	-	-	-
Moselle	GW-MSL210C	GW-MSL410C	-	-	-	-	-
Danube	GW-DAN210C	GW-DAN410C	GW-DAN656BC	-	-	-	GW-DAN1606C
Rhine	GW-RHN210C	GW-RHN410C	-	-	-	-	-
Murray	GW-MUR210C	GW-MUR410C	-	-	-	-	-
Bosphorus	GW-BOS210C	GW-BOS410C	-	-	-	-	-
Orinoco	GW-ORN210C	GW-ORN410C	-	-	-	-	-
Mackenzie	GW-MAC210C	GW-MAC410C	-	-	-	-	-
Perfume	-	-	-	-	GW-PFM3010C	-	-
Ebro	GW-EBO210C	GW-EBO410C	-	-	GW-EBO3010C	-	-
Rio Grande	-	GW-RIO410C	-	GW-RIO846C	GW-RIO3010C	-	-
Mekong	GW-MEK210C	GW-MEK410C	-	GW-MEK846C	GW-MEK3010C	GW-MEK1636C	GW-MEK1606C
Tigris	GW-TIG210C	GW-TIG410C	-	-	-	-	-
Sala	GW-SAA210C	GW-SAA410C	-	-	-	-	-
Chenab	GW-CHB210C	GW-CHB410C	-	-	GW-CHB3010C	-	-
Thames	GW-THA210C	GW-THA410C	GW-THA656BC	-	GW-THA3010C	GW-THA1636C	GW-THA1606C
Yukon	GW-YUK210C	GW-YUK410C	-	-	-	-	-
Avon	GW-AVO210C	GW-AVO410C	-	-	GW-AVO3010C	GW-AVO1636C	-
Indus	GW-IND210C	GW-IND410C	-	GW-IND846C	GW-IND3010C	GW-IND1636C	GW-IND1606C

NEW PRODUCT

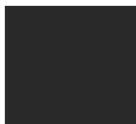
plain coloured glass

Size (mm)	600 x 300 x 6mm	200 x 100 x 8mm Bevel	100 x 100 x 8mm Bevel Finishing	600 x 750 x 6mm Splashback	900 x 750 x 6mm Splashback	1000 x 140 x 6mm Upstand	152 x 75 x 6
Size (Inches)	11 ³ / ₁₆ x 23 ⁵ / ₁₆ x 1/4	4 x 8 x 5/16 Bevel	4 x 4 x 5/16 Bevel Finishing	23 ³ / ₈ x 29 ¹ / ₂ x 3/8 Splashback	29 ¹ / ₂ x 35 ⁷ / ₁₆ x 3/8 Splashback	5 ¹ / ₂ x 39 ³ / ₈ x 3/8 Upstand	3 x 6 x 1/2
Shape (not to scale)							
Arctic	GW-ART6030C	GW-ART2010B	GW-ART1010B	GW-ART2406C #	GW-ART3606C #	GW-ART10014C #	GW-ART1575C
Volga	GW-VOL6030C	GW-VOL2010B	GW-VOL1010B	GW-VOL2406C #	GW-VOL3606C #	GW-VOL10014C #	-
Columbia	-	-	-	-	-	-	-
Mississippi	GW-MSP6030C	GW-MSP2010B	GW-MSP1010B	GW-MSP2406C #	GW-MSP3606C #	GW-MSP10014C #	-
Arkansas	-	-	-	-	-	-	-
Amazon	-	-	-	-	-	-	-
Mohaka	GW-MOH6030C	GW-MOH2010B	GW-MOH1010B	GW-MOH2406C #	GW-MOH3606C #	GW-MOH10014C #	-
Nile	-	-	-	-	-	-	-
Zambezi	-	-	-	-	-	-	-
Colorado	GW-COR6030C	GW-COR2010B	GW-COR1010B	-	-	-	-
Missouri	-	-	-	-	-	-	-
Seine	-	-	-	-	-	-	-
Loire	-	-	-	-	-	-	-
Moselle	-	-	-	-	-	-	-
Danube	-	-	-	-	-	-	-
Rhine	-	-	-	-	-	-	-
Murray	-	-	-	-	-	-	-
Bosphorus	-	-	-	-	-	-	-
Orinoco	-	-	-	-	-	-	-
Mackenzie	-	-	-	-	-	-	-
Perfume	GW-PFM6030C	GW-PFM2010B	GW-PFM1010B	GW-PFM2406C #	GW-PFM3606C #	GW-PFM10014C #	-
Ebro	GW-EBO6030C	GW-EBO2010B	GW-EBO1010B	GW-EBO2406C #	GW-EBO3606C #	GW-EBO10014C #	-
Rio Grande	GW-RIO6030C	GW-RIO2010B	GW-RIO1010B	-	-	-	-
Mekong	GW-MEK6030C	GW-MEK2010B	GW-MEK1010B	GW-MEK2406C #	GW-MEK3606C #	GW-MEK10014C #	-
Tigris	-	-	-	-	-	-	-
Sala	-	-	-	-	-	-	-
Chenab	-	GW-CHB2010B	GW-CHB1010B	GW-CHB2406C #	GW-CHB3606C #	GW-CHB10014C #	-
Thames	-	-	-	GW-THA2406C #	GW-THA3606C #	GW-THA10014C #	-
Yukon	-	-	-	-	-	-	-
Avon	-	-	-	GW-AVO2406C #	GW-AVO3606C #	GW-AVO10014C #	-
Indus	GW-IND6030C	GW-IND2010B	GW-IND1010B	GW-IND2406C #	GW-IND3606C #	GW-IND10014C #	-

Please see pages 94-96 for important information on Splashbacks.

Merci de regarder les pages 94-96 pour des informations importantes concernant les « Splashbacks »

Bitte beachten Sie weitere wichtige Informationen zu Splashbacks auf den Seiten 94-96.

Kijk alstublieft op bladzijde 94-96 voor de belangrijke informatie over Splashbacks.

Пожалуйста, см. Страницы 94-96 для получения важной информации о Splashbacks.

NEW PRODUCT

frosted glass

Size (mm)	100x100x10	398x80x6
Size (Inches)	4 x 4 x 3/8	3 1/8 x 15 3/4 x 1/4
Shape (not to scale)		
Arctic	GW-ART410F	GW-ART1636F
Volga	GW-VOL410F	GW-VOL1636F
Columbia	GW-COL410F	-
Mississippi	GW-MSP410F	-
Amazon	GW-AMA410F	-
Nile	GW-NIL410F	-
Zambezi	GW-ZAM410F	-
Colorado	GW-COR410F	-
Missouri	GW-MOR410F	-
Seine	GW-SEN410F	-
Loire	GW-LOR410F	-
Danube	GW-DAN410F	-
Rhine	GW-RHN410F	-
Murray	GW-MUR410F	-
Orinoco	GW-ORN410F	-
Yukon	GW-YUK410F	-
Thames	GW-THA410F	GW-THA1636F



how many tiles will you need?

De combien de carreaux aurez-vous besoin? / Wie viele Fliesen brauchen Sie? / Hoeveel mozaïektegels hebt u nodig? / Сколько плитки вам понадобится?

Nominal size*		Per m ²	Per ft ²
Tiles / Carreaux / Fliesen / Tegels			
48 x 48mm	1 7/8" x 1 7/8"	435.0	36.0
100 x 100mm	4" x 4"	100.0	9.0
152 x 50mm	2" x 6"	131.0	12.0
150 x 75mm	3" x 5 1/4"	88.0	8.0
152 x 75mm	3" x 6"	86.0	8.0
200 x 75mm	3" x 7 7/8"	66.66	6.2
220 x 76mm	3" x 8 3/8"	59.8	5.56
200 x 98mm	4" x 8"	50.0	4.5
200 x 100mm	4" x 8"	50.0	4.5
295 x 295mm	11 1/8" x 11 1/8"		
1 x Hexagon Sheet	-	17.5	1.63
300 x 100mm	4" x 11 3/4"	33.33	3.06
300 x 300mm	11 1/4" x 11 1/4"	10.7	1
305 x 305mm	12" x 12"	10.4	1

Nominal size*		Per m ²	Per ft ²
Tiles / Carreaux / Fliesen / Tegels			
310 x 310mm	12 3/16" x 12 3/16"	10.4	1
315 x 305mm	12 x 12 3/8"	10.4	1
398 x 80mm	3 1/8" x 15 3/4"	31.0	2.9
398 x 198mm	7 7/8" x 15 3/4"	12.5	1.2
402 x 205mm	8 1/8" x 15 1/16"	12.13	1.13
600 x 300mm	11 3/16" x 23 3/8"	5.55	0.52
600 x 200mm	7 7/8" x 23 3/8"	8.3	0.75
600 x 750mm	29 1/2" x 23 3/8"	3.70	0.21
900 x 750mm	29 1/2" x 35 7/16"	2.22	0.14
1000 x 140mm	5 1/2" x 39 3/8"	7.14	0.67
Borders / Bordures / Borten / Randen		Per linear m	Per linear ft
298mm	11 3/4"	3.4	1.0
300mm	11 3/4"	3.3	1.0

*All of the above dimensions are subject to a tolerance of ± 2.5 mm or $3/32$ ". Quantities shown exclude grout gaps between each tile. Please allow an additional 5% for cutting/wastage.

*Remarque: Toutes les dimensions précédentes sont sujettes à une tolérance de ± 2.5 mm. Les quantités démontrées n'incluent pas les joints entre les carreaux. Nous vous recommandons de prévoir au moins 5% supplémentaires pour les chutes.

*Beachten Sie bitte: Alle oben genannten Abmessungen können Abweichungen von ± 2.5 mm aufweisen. Angegebene Mengen schliessen die Fugen zwischen jeder Fliese aus. Es empfiehlt sich, mindestens 5% material für etwaiger Bruch einzuplanen.

*Voor alle afmetingen geldt een tolerantiewaarde van ± 2.5 mm. Voeg openingen tussen tegels zijn niet meegerekend in de aangegeven hoeveelheden. Houd rekening met vijf procent snijverlies.

*Все размеры выше указаны с погрешностью ± 2.5 мм. В указанном количестве не учтены зазоры между плитками. Прибавьте допуск на отходы в размере 5%.

DIMENSIONS

Nominal dimensions for all Original Style Glassworks tiles are shown throughout the brochure. Actual dimensions for individual tiles may vary from these figures. We recommend you allow for at least an additional 5% for cutting/wastage.

DIMENSIONS

Les dimensions nominales de tous les carreaux Glassworks sont indiquées au fil de la brochure. En raison de la méthode de fabrication les dimensions réelles de chaque carreau peuvent être légèrement différentes des chiffres indiqués donc nous vous recommandons de prévoir au moins 5 % supplémentaires pour les découpes/chutes.

ABMESSUNGEN

Die Abmessungen aller Original Style Glassworks Fliesen in dieser Broschüre sind Nennwerten. Die tatsächlichen Abmessungen einzelner Fliesen können von diesen Werten abweichen. Es empfiehlt es sich, mindestens 5% mehr Material für etwaigen Bruch oder falschen Zuschnitt einzuplanen.



AFMETINGEN

De nominale afmetingen voor alle Original Style Glassworks tegels staan vermeld in de brochure. De werkelijke afmetingen kunnen afwijken van deze cijfers. We raden dat u minstens 5% toevoegtaan uw bestelling voor snijverlies.

РАЗМЕРЫ

Номинальные размеры всей плитки Original Style Glassworks указаны в брошюре. Реальные размеры каждой плитки могут отличаться от указанных. Мы рекомендуем учитывать допуск на отходы не менее 5%.

suitability

KEY TO SYMBOLS Signification des symbols Symbolerklrung Sleutel voor symbolen Расшифровка символов	
	Wet and dry walls Murs secs et humides (dont douches et douches italiennes) Nass- und Trockenmauern (Inkl. Duschen und Nassrume) Natte en droge wanden (incl. douches) Для стен во влажных и сухих средах (вкл. душевые и гидроизолированные комнаты)
	Dry walls only Murs secs uniquement Nur fur Trockenwande Alleen droge wanden Для стен только в сухих средах

important information

SUITABILITY

Most glassworks tiles and splashbacks are suitable for internal walls in both wet and dry areas, in residential and commercial applications – please see suitability symbols for individual products.

They are not suitable for:

- worktops, as they are susceptible to scratching.
- floors
- external use
- installation in submerged conditions such as swimming pools or fish tanks
- installation over substrates that are subject to movement such as wood or fibreglass
- fire place recesses and wood burner surrounds

If installed in direct sunlight the colours may fade.

SHADING

As each tile is individually coloured, there may be distinctive yet subtle variations in shade, especially between batches. This is an inherent feature of Original Style tiles. You may wish, therefore, to spend some time to achieve the most pleasing distribution of shades before fixing. When planning designs it is important to dry lay the tiles prior to fixing. This is particularly relevant regarding Metallica tiles. We recommend that you buy all the tiles you need for your project at one time. Decorative tiles are made individually and therefore unique. Because of the way they are made, Aurora Borealis tiles have distinct differences between them, and if they are placed together they may not match or line up with each other, however the overall effect will be stunning. Tiles, mosaics and splashbacks of the same colour but with a different thickness may vary in tone.

There may also be shade variations with Champagne and Zinc splashbacks and tiles. The backs of these tiles and mosaics are painted by hand and so each individual tile will be unique: Arabia, Arabia Mosaic, Ammon Mosaic, Siva Mosaic

ARCTIC WHITE TILES

Please be aware that the Arctic White colour is achieved by using an optical clear glass. When two tiles of different length are placed side by side the amount of light passing through the tile can affect the colour. This effect is caused by refraction, prismatic effect or chromatic aberration. We recommend that any voids (e.g. corners) are fully filled before tiling to avoid this or other shadowing effects. The glass should also be cut using a suitable glass cutting electric tile saw with a glass cutting blade, with any uneven edges filed away with a suitable glass file. NB Arctic White splashbacks must NOT be cut.

SPLASHBACKS

Care must be taken when handling all splashbacks before and during installation. Most of Original Style Glassworks splashbacks have been tested to British Standards BS EN 12150. These splashbacks have been made from toughened (also known as tempered) glass, which is a type of safety glass. Toughened glass should receive the same care as annealed (ordinary) glass. Careless handling and improper installation sometimes causes edge damage, and delayed breakage can occur when edge-damaged tempered glass is subjected to mechanical stress, as in installation. Further, if cut, knocked or dropped, this material will produce instantaneous total fragmentation.

DO NOT under any circumstances attempt to cut or drill splashbacks as they will shatter. However these Aurora Borealis splashbacks can be cut, as they not made from toughened glass. However they should be handled and treated in exactly the same way as those made from toughened glass:

GW-AQA2406C, GW-AQA3606C Aurora Borealis Aqua
GW-AUR2406C, GW-AUR3606C Aurora Borealis Aura
GW-VEN2406C, GW-VEN3606C Aurora Borealis Ventu

The other glass tiles, including upstands, can be cut. An acceptable tile cutter is a Rubi DW250N with a CPC2 blade. Tiles may also be scribed and snapped using a Rubi TR tile cutter with a 18mm scoring wheel. Appropriate safety precautions must be taken when cutting glass. Please refer to our Fixing Guide at www.originalstyle.com/guides

MIRROR FACET MOSAICS

The Mirror Facet mosaics (pages 62-65) may have sharp edges. Please take extra care during handling and installation.

INSTALLATION

Please visit www.originalstyle.com/fixing-guides/ to view our fixing guides and instructional videos on how to cut and install glass tiles.

Near Heat Sources

All Glassworks tiles including Splashbacks must be installed a minimum of 3cm (1 1/8") from any heat source. This will include any hot water pipework concealed within walls and any radiant heat sources such as hobs, heated towel rails or radiators. Hot pans must not come in direct contact with glass Splashbacks.

When fixing glass tiles in wet areas the walls must be fully waterproofed (tanked) prior to tiling.

We do not recommend using Glass Strip Borders on areas subject to movement, i.e. timber walls, as the substrate may cause glass strips to fracture.

Grouting

Always allow a 2-3mm grout gap. Glass tiles must NEVER be butt jointed against one another as they could either crack or de-bond.

Please refer to the Fixing Guide at www.originalstyle.com/guides before commencing any installations as Original Style cannot accept responsibility for any faults after tiles have been fixed.

In the USA please follow the recommendations of reputable product manufacturers in conjunction with our Fixing Guide at www.originalstyle.com/guides and always comply with American National Standards Institution (ANSI) specifications as set out in the Handbook for Ceramic Tile Installation published by the Tile Council of America. Useful links: ctioa.org, tileusa.com

OTHER ORIGINAL STYLE RANGES

Other Original Style products, such as mosaics, ceramic, porcelain and stone tiles, which are shown in this brochure, have their own installation requirements. Please ensure you refer to the relevant Original Style brochure and Fixing Guides at www.originalstyle.com for these products before installing.

PHOTOGRAPHY

Owing to variations in studio lighting and printing inks, the tile colours shown in this catalogue may differ slightly from those of the actual tiles. Before making your choice it is always advisable to ask your Original Style retailer to show you samples.

LIMITS OF LIABILITY

Original Style accepts no liability for the faulty installation of its products. In the case of any claim relating to the tiles themselves, Original Style's liability, to the extent permitted by law, is limited to either the replacement of the product or a refund of the cost of the product, and does not extend to cover any consequential loss. Claims must be reported within seven working days from receipt of the tiles. Tiles must be inspected prior to installation and claims cannot be considered after the tiles have been installed. Please be advised that installation constitutes acceptance of the quality, colour, size, texture and shade of the tiles. Original Style warrants that its tiles conform to their description and are fit for their purpose. Original Style makes no other express or implied warranty as to fitness or suitability of the products for particular installations. We extend no guarantees, express or implied, as to wear resistance or maintenance procedures. It is imperative to follow grout and adhesive manufacturers' instructions regarding their suitability with our products. If in doubt please consult the grout/adhesive stockist from whom you purchased the products. Original Style makes no representations as to the fitness for purpose of third party adhesives and grouts. Please note the use of certain acid based cleaning products may cause some of the tiles to react and change in character.

informations essentielles

USAGES

La plupart des carreaux Glassworks et Splashbacks conviennent aux murs internes de zones sèches et humides, dans des installations commerciales et domestiques – veuillez-vous référer aux symboles pour connaître l'usage de chaque produit.

Ils ne conviennent pas pour :

- Les plans de travail car ils sont sensibles aux rayures,
- Les sols,
- Les usages extérieurs,
- L'installation dans des conditions immergées comme les piscines ou aquariums,
- L'installation sur des supports sujets au mouvement comme le bois ou la fibre de verre,
- Les niches de cheminée et autour des poêles à bois

Si les carreaux Glassworks sont installés à la lumière directe du soleil, les couleurs peuvent s'estomper.

TEINTES

Les carreaux de verre étant colorés individuellement, ils peuvent présenter des variations et nuances surtout entre « bains » différents. Il s'agit là d'un trait de caractère propre aux carreaux Glassworks et Serenity Original Style. Nous vous conseillons par conséquent de prendre le temps nécessaire pour distribuer les teintes de manière harmonieuse avant de coller vos carreaux. Ceci s'applique surtout aux carreaux Metallica donc il est préférable de commander tous vos carreaux en même temps. Les carreaux décoratifs sont tous fabriqués séparément, pour cette raison ils sont uniques. En raison de la méthode de production les Splashbacks et carreaux satinés « Aurora Borealis » présenteront des différences de carreau à carreau donc les marquages ne se marieront pas parfaitement, néanmoins l'effet final sera superbe. Les carreaux, mosaïques et Splashbacks de la même couleur mais avec une épaisseur différente peuvent avoir une variation de teinte.

Il peut aussi y avoir des variations de teinte avec les carreaux et Splashbacks Champagne et Zinc. Le dos de ces carreaux et mosaïques sont peints à la main, ainsi chaque carreau sera unique : Arabia, Arabia Mosaic, Ammon Mosaic, Siva Mosaic.

CARREAUX Arctic WHITE

Il faut savoir qu'en raison de l'utilisation de verre transparent pour fabriquer les carreaux Arctic White si deux carreaux de longueur différents sont placés côte à côte la couleur peut paraître légèrement différente selon la lumière qui les traverse. Cet effet est causé par la réfraction, effet prismatique ou aberration chromatique. Nous recommandons de remplir pleinement tous les vides (ex : angles) avant de poser les carreaux afin d'éviter tout effet d'ombre. Il faut aussi couper les carreaux à l'aide d'un coupe-carrelage adapté et limer les bords vifs avec une lime spécialement pour le verre. NB – Les Splashbacks Arctic White ne doivent pas être découpés.

SPLASHBACKS

Veuillez toujours manipuler les Splashbacks avec le plus grand soin, aussi bien avant que pendant leur installation. La plupart des Splashbacks d'Original Style ont été testés conformément à la norme britannique BS EN 12150. Ceux-la sont fabriqués en verre trempé, une variété de verre de sécurité. Le verre trempé doit être manipulé tout aussi soigneusement que le verre recuit (le verre ordinaire). Une manipulation peu soignée et une mauvaise installation peuvent endommager les bords, et les carreaux aux bords abîmés pourront finir par se briser lorsque le verre trempé est soumis à une tension mécanique, par exemple au cours de l'installation. De plus, ce matériau se fragmentera instantanément et totalement s'il est découpé, s'il tombe ou s'il reçoit un choc.

N'ESSAYEZ PAS, sous aucune circonstance, de découper ou de perforez un Splashback car il se brisera. Les Splashbacks Aurora Borealis ne sont pas en verre trempé et peuvent donc être découpés mais doivent tout de même être manipulés avec grand soin :

GW-AQA2406C, GW-AQA3606C Aurora Borealis Aqua
GW-AUR2406C, GW-AUR3606C Aurora Borealis Aura
GW-VEN2406C, GW-VEN3606C Aurora Borealis Ventus

Les autres carreaux de verre ainsi que les « upstands » peuvent être découpés. Un exemple de coupe-carrelage adapté est le Rubi DW250N avec un disque CPC2. Les carreaux peuvent aussi être coupés avec une coupeuse manuelle Rubi TR avec une molette de 18mm. Il est recommandé de prendre des précautions supplémentaires en découpant le verre. Merci de vous reporter au guide d'installation sur www.originalstyle.com/guides

MOSAÏQUES MIRROR FACET

Les mosaïques Mirror Facet (pages 62-65) peuvent avoir les bords coupants. Veuillez donc les manipuler avec le plus grand soin durant l'installation.

INSTALLATION

Utilisation à proximité d'une source de chaleur

Original Style recommande d'installer tous carreaux en verre, les Splashbacks inclus, à au moins 3 cm des sources de chaleur. Sont incluses ici toutes les tuyauteries d'eau chaude dissimulées à l'intérieur des cloisons ainsi que toutes les sources de chaleur rayonnantes telles que les sèche-serviette ou les radiateurs. Les casseroles chaudes ne doivent pas entrer en contact direct avec les Splashbacks.

Si vous installez les carreaux en verre dans des zones humides, les murs doivent être imperméabilisés avant de carreler.

Nous ne recommandons pas l'usage des Glass Strip Bordes sur des zones sujettes au mouvement, cad les murs et ossatures en bois, car le support pourrait causer la fissure des bandes de verre.

Joins

Nous recommandons un espace de 2-3mm pour les joints. Les carreaux en verre de doivent JAMAIS carreler sans écart pour les joints car ils pourraient se fissurer ou se décoller.

Merci de vous reporter au guide d'installation sur www.originalstyle.com/guides avant de commencer l'installation de votre carrelage Original Style car nous ne pouvons accepter la responsabilité pour les défauts une fois l'installation faite.

AUTRES GAMMES ORIGINAL STYLE

L'installation des autres produits Original Style présentés dans la brochure, tels que les mosaïques, les carreaux en porcelaine, céramique et les pierres, nécessite des précautions différentes. Veuillez-vous reporter à la brochure Original Style correspondante ou au guide d'installation sur www.originalstyle.com avant de procéder à l'installation.

PHOTOGRAPHIES

L'éclairage en studio et les encres utilisées pour l'impression peuvent affecter les couleurs des carreaux présentés dans ce catalogue. Avant de passer votre commande, il est toujours préférable de vous procurer des échantillons auprès d'un revendeur Original Style.

LIMITATION DE RESPONSABILITE

Original Style dégage toute responsabilité en cas d'installation incorrecte de ses produits. En cas de réclamation relative aux carreaux eux-mêmes, la responsabilité d'Original Style sera confinée, dans la limite autorisée par la loi, au remplacement du produit ou au remboursement du prix du produit, et ne couvre pas les dommages indirects. Toute réclamation doit être effectuée dans les sept jours suivant la réception des carreaux. Les carreaux doivent être inspectés avant installation. Aucune réclamation ne sera prise en compte une fois les carreaux installés. Notez que l'installation du carrelage constitue l'acceptation de la qualité, de la couleur, de la texture, de la taille et de la teinte des carreaux. Original Style garantit que ses carreaux sont conformes au descriptif fourni et qu'ils sont adaptés à l'usage pour lequel ils sont prévus. Original Style ne formule aucune garantie expresse ou implicite supplémentaire vis-à-vis de l'adéquation ou de la compatibilité de ses produits dans des installations spécifiques. Nous ne formulons aucune garantie, expresse ou implicite, vis-à-vis de la résistance à l'usure ou des procédures d'entretien. Il est impératif de suivre les instructions des fabricants de colles et de ciments-joints afin d'en vérifier la compatibilité avec nos produits. En cas de doute, consultez le revendeur qui vous aura fourni la colle ou le ciment-joint. Original Style n'assumera aucune responsabilité en ce qui concerne la compatibilité ou l'usage de colles et de ciments-joints tiers. Veuillez noter que l'utilisation de certains produits nettoyeurs à base d'acide peut provoquer des réactions sur certains carreaux et en modifier les caractéristiques.

wichtige informationen

ABMESSUNGEN

Bei allen Maßangaben in diesem Katalog handelt es sich um Nennwerte. Die tatsächlichen Maße einzelner Fliesen können von diesen Werten abweichen. Wir empfehlen mind. 5% mehr Material für Bruch oder Verschnitt einzuplanen.

EIGNUNG

Die meisten unserer Glassworks Fliesen und Splashbacks eignen sich für Trocken- und Feuchträume (nur Innenbereiche) sowie private und gewerbliche Bauvorhaben. Bitte beachten Sie die Eignungssymbolik in der jeweiligen Produktbeschreibung.

Glassworks Artikel eignen sich nicht für:

- Arbeitsflächen (Verkratzungsgefahr)
- Böden
- Außenbereiche
- Unterwasserinstallationen (z.B. Pools, Aquarien)
- Installationen über beweglichem Trägermaterial (z.B. Holz, Glasfaser)
- Kamin- und Brennöfen

Glassworks Fliesen können verblassen, wenn Sie direktem Sonnenlicht ausgesetzt werden.

FARBABWEICHUNGEN UND FARBNUANZEN

Da jede Fliese individuell koloriert wird, können einzelne Fliesen derselben Farbe in ihrer Tonalität voneinander abweichen, besonders zwischen Chargen. Dieses ist ein charakteristisches Merkmal von Original Style Fliesen. Legen Sie die Fliesen vor dem Verlegen lose aus, um etwaige Farbabweichungen gleichmäßig zu verteilen und die gewünschte Optik zu erzielen. Dies gilt besonders für Fliesen unserer Metallica-Serie. Wir empfehlen stets alle für ein Projekt benötigten Fliesen auf einmal zu kaufen. Dekorfliesen werden individuell hergestellt und sind daher Unikate. Aurora Borealis weisen aufgrund ihres Herstellungsprozesses unterschiedliche Farbverläufe auf, die sich nicht zwangsläufig aneinander ausrichten lassen. Dennoch ist die Gesamtwirkung beeindruckend. Fliesen, Mosaik und Splashbacks der gleichen Farbe, aber von unterschiedlicher Dichte, können ebenfalls verschiedene Nuancen aufweisen.

Die Farben Champagne und Zinc neigen ebenfalls verstärkt zu Farbabweichungen. Die Rückseiten der folgenden Fliesen werden von Hand eingefärbt und sind daher ebenfalls in Ihrer Farbgebung einzigartig: Arabia, Arabia Mosaic, Ammon Mosaic, Siva Mosaic.

Arctic weiße Fliesen:

Bitte beachten Sie, dass die Farbe Arctic White mit klarem optischen Glas erzeugt wird. Wenn zwei Fliesen unterschiedlicher Kantenlängen nebeneinander verlegt werden, kann der Lichteinfall die wahrgenommene Farbe beeinflussen. Dieser Effekt entsteht durch Refraktion, prismatische Effekte oder chromatische Aberration. Wir empfehlen alle Lücken (z. B. Ecken) vor dem Verlegen zu füllen, um Schatteneffekte zu vermeiden. Die Fliesen sollten außerdem mit einem geeigneten Schneidegerät mit Glasschneideblatt geschnitten und jegliche Unebenheiten mit einer Glasfeile vor Verlegung ausgeglichen werden. Splashbacks dürfen NICHT geschnitten werden.

SPLASHBACKS

Splashbacks müssen vor und während der Installation mit Sorgfalt behandelt werden. Der Großteil unserer Glassworks Splashbacks wurden nach der britischen Norm BS EN 12150 getestet. Sie sind aus gehärtetem Glas hergestellt (auch vorgespanntes Glas genannt), das eine Art von Sicherheitsglas darstellt. Hartglas muss mit der gleichen Sorgfalt behandelt werden wie vergütetes (gewöhnliches) Glas. Mangelnde Sorgfalt bei der Handhabung und unsachgemäße Installation kann Kantenschäden verursachen. Ein verzögerter Bruch kann auftreten, wenn kantengeschädigtes Hartglas einer mechanischen Beanspruchung ausgesetzt wird, wie z.B. bei der Verlegung. Wenn dieses Glas geschnitten, gestoßen oder fallen gelassen wird, zersplittert es sofort.

Versuchen Sie AUF KEINEN FALL Splashbacks zu schneiden oder zu bohren, da das Glas sonst zerbricht. Lediglich die Serie Aurora Borealis Splashbacks kann zugeschnitten werden, da diese nicht aus gehärtetem Glas gefertigt ist. Sie sollten sie jedoch mit der gleichen Sorgfalt wie Sicherheitsglas behandeln:

GW-AQA2406C, GW-AQA3606C Aurora Borealis Aqua
GW-AUR2406C, GW-AUR3606C Aurora Borealis Aura
GW-VEN2406C, GW-VEN3606C Aurora Borealis Ventus

Unsere sonstigen Glasfliesen, einschließlich Upstands können geschnitten werden. Als Glasschneider eignet sich ein Rubi DW250N mit einem CPC2 Schneideblatt. Es ist zudem möglich, Glasfliesen mit einem Rubi TR Schneider mit 18 mm Rad anzuritzen und zu brechen. Beim Schneiden von Glas sind entsprechende Vorsichtsmaßnahmen zu treffen. Lesen Sie hierzu bitte unsere Installationsanleitung unter www.originalstyle.com/guides.

MIRROR-FACET MOSAICS

Verspiegelte Mosaik (S. 62-65) können scharfe Kanten haben. Bitte beachten Sie beim Verlegen entsprechende Vorsichtsmaßnahmen.

INSTALLATION IN DER NÄHE VON WÄRMEQUELLEN

Alle Glassworks Fliesen, einschließlich der Splashbacks, müssen mit einem Abstand von mindestens 3 cm zu Wärmequellen installiert werden. Hierzu zählen im Mauerwerk verlegte Heiz-/Wasserrohre, Heizkörper, Backöfen und Kochfelder sowie Handtuchwärmer. Heiße Pfannen und Töpfe dürfen nicht in direkten Kontakt mit Splashbacks gelangen.

Beim Verlegen von Glasfliesen in Feuchträumen müssen die Wände stets abdichtet werden, so dass sie vollständig wasserdicht sind.

Wir empfehlen nicht, Glass Strip Borders auf sich bewegendem Trägermaterial zu installieren (z.B. Holzwände), da durch die entstehende Spannung diese Zierkanten splintern können.

VERFUGEN

Wir empfehlen eine Fugenbreite von 2-3mm. Glasfliesen dürfen NIE fugenlos aneinandergesetzt werden, da diese springen oder sich lösen könnten.

Bitte beachten Sie vor der Verlegung unbedingt unsere Verlegeanleitung unter www.originalstyle.com/guides. Eine Haftung seitens Original Style ist nach dem Verlegen ausgeschlossen.

WEITERE ORIGINAL STYLE PRODUKTE

Bitte beachten Sie, dass für Produkte anderer Original Style Serien, die in diesem Katalog abgebildet sind (z.B. Keramik und Naturstein) gesonderte Anforderungen und Installationshinweise gelten. Informationen hierzu finden Sie im entsprechenden Katalog oder unseren Verlegeanleitung unter www.originalstyle.com.

PHOTOGRAPHIE

Aufgrund variierender Beleuchtungsverhältnisse im Studio oder bei Druckfarben können die im Katalog zu sehenden Farben geringfügig von der tatsächlichen Farbgebung abweichen. Bevor Sie Ihre Auswahl treffen, sollten Sie immer zuvor einen Einzelhändler für Original Style nach Mustern fragen.

HAFTUNGSBESCHRÄNKUNG

Original Style übernimmt für die fehlerhafte Installation seiner Fliesen keine Haftung. Sollte es Reklamationen bezüglich der Fliesen selbst geben, dann beschränkt sich die gesetzlich eingeräumte Haftung von Original Style lediglich auf den Artikelaustausch oder Kostenrückerstattung. Weitere Schäden werden nicht abgedeckt. Vor der Installation sind die Fliesen zu prüfen. Nachträgliche Reklamationen können nicht berücksichtigt werden. Bitte beachten Sie, dass Sie durch die Installation anzeigen, dass hinsichtlich Qualität, Farbgebung, Textur, Größe oder Schattierung keine Beanstandungen vorliegen. Original Style gewährleistet die beschreibungs- und zweckgemäße Fabrikationsausführung der Fliesen. Original Style gibt keine weiteren ausdrücklichen oder impliziten Garantien hinsichtlich Eignung der Artikel für besondere Installationsarten. Wir geben weder ausdrücklich noch implizit eine Garantieverlängerung auf Abnutzungsverhalten oder Wartungsarbeiten. Beachten Sie bitte, dass die Fliesen auf Säure basierte Reinigungsmittel reagieren und ihr Aussehen verändern können.

belangrijke informatie

GESCHIKTHEID

De meeste Glassworks tegels en Splashbacks zijn geschikt voor muren in droge en natte ruimtes, voor residentiële en commerciële doeleinden – zie de geschiktheidssymbolen voor meer informatie.

Deze tegels zijn niet geschikt voor:

- Aanrechtbladen aangezien deze zullen krassen
- Vloeren
- Buitenmuren
- Installaties onder water zoals zwembaden en aquariums
- Installaties op ondergronden met beweging zoals hout en glasvezel
- In open haarden en om houtkachels

Wanneer de tegels in direct zonlicht geplaatst worden, kan de kleur metertijd vervagen.

KLEURNUANCES

Omdat elke tegel afzonderlijk wordt gekleurd, kan er sprake zijn van zichtbare, subtiele kleurnuances, vooral tussen partijen. Dit is een karakteristieke eigenschap van Original Style tegels. Het kan de moeite lonen om, voordat de tegels worden aangebracht, de verschillende tinten zo te verdelen dat u tevreden bent over het geheel. Het is belangrijk dat u de tegels uitlegt voorafgaand aan het installeren bij het plannen van ontwerpen. Dit geldt met name voor de tegels van Metallica. We raden ten zeerste aan dat u alle benodigde tegels tegelijkertijd koopt. Decoratieve tegels worden per stuk gemaakt en zijn daarom uniek. Als gevolg van hoe de Aurora Borealis Splashbacks worden gefabriceerd, zijn er zichtbare verschillen deze de individuele tegels. Als meerdere tegels worden gebruikt in een installatie, dan kan het zijn dat de patronen niet op elkaar aansluiten. Het overkoepelende effect is echter prachtig. Tegels, mozaïeken en Splashbacks met dezelfde kleur, maar met verschillende dikte, kunnen in nuance variëren.

Wegens hun metalic effecten kunnen er ook kleurnuances zijn tussen Champagne en Zinc Splashbacks en glazen tegels. Arabia, Arabia Mosaic, Ammon Mosaic, Siva Mosaic: Doordat de achterkant van deze glazen tegels en mozaïeken met de hand geschilderd zijn, is iedere tegel uniek.

ARCTIC WHITE TILES

Omdat de kleur Arctic White wordt gecreëerd door gebruik te maken van optisch helder glas, moeten klanten zich ervan bewust zijn dat wanneer twee tegels van verschillende lengte naast elkaar geplaatst worden, de hoeveelheid licht dat door de tegels gaat, de kleur kan beïnvloeden. Dit effect is het gevolg van lichtbreking, prismatisch effect of chromatische aberratie. Wij raden aan dat openingen (bijvoorbeeld hoeken) volledig opgevuld worden voordat u begint met het installeren van de tegels om dit en andere schaduweffecten te voorkomen. Het glas moet daarnaast ook gesneden worden met een geschikte elektrische slijpsnijder met een zaagblad voor glazen tegels en oneffen randen weggevlind met een geschikte glasvijl. Arctic White Splashbacks mogen NIET gesneden worden.

SPLASHBACKS

Wees voorzichtig in de omgang met Splashbacks voorafgaand aan en tijdens de installatie. De meeste Original Style Glassworks Splashbacks zijn getest volgens de British Standards BS EN 12150. Deze splashbacks bestaan uit gehard glas (ook wel bekend als gegloeid (normaal) glas. Onachtzame omgang en een verkeerde installatie kan soms leiden tot beschadigde hoeken. Op de lange termijn kan het glas breken als het geharde glas met beschadigde hoeken onderhevig is aan mechanische stress, zoals tijdens het zetten. Dit materiaal valt bovendien onmiddellijk volledig uiteen in kleine stukjes als het wordt gesneden, als u er tegenaan staat of als u het laat vallen. Probeer NOOIT op enigerlei wijze een Splashback te snijden of erin te boren, aangezien deze uiteenspat. De splashbacks hieronder zijn niet van gehard glas gemaakt maar moeten op dezelfde wijze verzorgd en behandeld worden als gehard glas :

GW-AQA2406C, GW-AQA3606C Aurora Borealis Aqua
GW-AUR2406C, GW-AUR3606C Aurora Borealis Aura
GW-VEN2406C, GW-VEN3606C Aurora Borealis Ventus

De andere glazen tegels, inclusief Upstands, kunnen worden gesneden. Een tegelsnijder die wij aanraden is de Rubi DW250N met een CPC2 zaagblad. Daarnaast kunt u tegels inkrasen en breken met een Rubi TR tegelsnijder (met een 18 mm snijwiel). Passende veiligheidsmaatregelen moeten in acht worden genomen bij het snijden van glas. Raadpleeg onze installatiegids op www.originalstyle.com/guides

MIRROR FACET MOZAÏEKEN

De Mirror Facet mozaïeken (pagina 62-65) hebben mogelijk scherpe randen. Wees extra voorzichtig in de omgang met deze tegels voorafgaand aan en tijdens de installatie.

INSTALLATIE

Warmtebronnen

Alle Glassworks tegels, waaronder Splashbacks, moeten op minstens 3 cm van een warmtebron worden geplaatst. Dit geldt ook voor warmwaterleidingen in muren en stralingswarmtebronnen, zoals kookplaten, verwarmde handdoekrekken en radiatoren. Hete pannen mogen niet in directe aanraking komen met glazen Splashbacks.

Wanneer glazen tegels in natte ruimtes geplaatst worden, moeten de muren voor het tegelzetten volledig waterdicht gemaakt en afgedicht worden.

Wij raden aan dat glazen sierstrippen niet op ondergronden geplaatst worden waar beweging in kan voorkomen, zoals bijvoorbeeld hout, aangezien de strippen kunnen barsten.

Voegen

Houdt altijd een voegbreedte van 2-3mm aan. Glazen tegels moeten nooit voegloos (koud) geplaatst worden aangezien de tegels dan kunnen scheuren of onthechten.

Raadpleeg de installatiegids op www.originalstyle.com/guides voordat u begint met het leggen, aangezien Original Style niet verantwoordelijk is voor defecten nadat de tegels zijn gezet.

ANDERE PRODUCTEN VAN ORIGINAL STYLE

Andere Original Style producten in deze brochure, zoals mozaïeken en keramische, porseleinen en stenen tegels, hebben hun eigen installatierichtlijnen. Raadpleeg de juiste Original Style brochure en installatiegids op www.originalstyle.com/guides, voor deze producten voordat u ze installeert.

FOTOGRAFIE

Als gevolg van variaties in studiobelichting en printinkten kunnen de in deze brochure afgebeelde kleuren enigszins afwijken van die van de daadwerkelijke tegels. We raden altijd aan dat u uw Original Style-leverancier vraagt om enkele voorbeelden.

AANSPRAKELIJKHEIDSBEPERKING

Original Style is niet aansprakelijk voor de verkeerde installatie van zijn producten. In geval van claims met betrekking tot de tegels zelf is de aansprakelijkheid van Original Style, voor zover dit wettelijk is toegestaan, beperkt tot het vervangen van het product of het vergoeden van de kosten van het product, en is gevolgschade niet inbegrepen. Claims moeten binnen zeven werkdagen na ontvangst van de tegels worden ingediend. De tegels moeten worden geïnspecteerd voordat deze worden gezet. Claims worden niet behandeld nadat de tegels zijn gezet. We wijzen u erop dat tot de zetting het aanvaarden van de hoeveelheid, kleur, structuur, afmetingen en schakering van de tegels behoort. Original Style garandeert dat zijn tegels overeenkomen met hun omschrijving en geschikt zijn voor het beoogde gebruik. Original Style maakt geen andere uitdrukkelijke of impliciete garanties met betrekking tot de geschiktheid van de producten voor bepaalde installaties. We maken geen garanties, uitdrukkelijk of impliciet, ten aanzien van slijtagebestendigheid of onderhoudsmaatregelen. Het is van groot belang dat de instructies van de producent voor voeg- en lijmmiddelen worden opgevolgd ten aanzien van hun geschiktheid in combinatie met onze producten. Raadpleeg de leverancier van de voeg- en lijmmiddelen van wie u de producten hebt gekocht in geval van twijfel. Original Style maakt geen bewegingen over de geschiktheid voor gebruik van de lijmen en voegmiddelen van derde partijen. We wijzen u erop dat het gebruik van bepaalde bijtende reinigingsmiddelen kan leiden tot een reactie van de tegels, waarvan het uiterlijk kan veranderen.

важная информация

РАЗМЕРЫ

Номинальные размеры всей плитки Original Style Glassworks указаны в брошюре. Реальные размеры каждой плитки могут отличаться от указанных. Мы рекомендуем учитывать допуск на отходы не менее 5%.

ВАРЬИРОВАНИЕ ПО ЦВЕТУ

Поскольку каждая плитка окрашивается индивидуально, возможно незначительное, но заметное отличие по цвету, особенно между плиткой из различных партий. Это характерная особенность плитки компании Original Style. Таким образом, перед укладкой вам может потребоваться некоторое время на то, чтобы обеспечить наиболее красивое распределение оттенков. При планировании дизайна обязательно предварительно разложите плитку на сухой поверхности, особенно если вы используете плитку Metallica. Мы настоятельно рекомендуем покупать всю плитку, необходимую для проекта, за один раз. Каждая декоративная плитка изготавливается индивидуально, а следовательно каждая плитка уникальна. Плитки, мозаики и Splashbacks одного цвета, но с разной толщиной по причине разной плотности различаются по тону.

В связи с особенностями методики изготовления между плиткой Aurora Borealis Splashbacks и матовой плиткой имеется значительная разница, поэтому если отдельные плитки положить рядом, они не будут подходить друг другу, однако общий эффект от выложенной ими поверхности будет потрясающим. Также вариации в тоне расцветки могут быть присущи плитке Champagne и Zinc Splashbacks. Arabia, Arabia Mosaic, Ammon Mosaic, Siva Mosaic. Обратная сторона этой плитки раскрашена вручную и поэтому каждая индивидуальная плитка уникальна.

ОСОБОЕ ЗАМЕЧАНИЕ: плитка Arctic White

Цвет Arctic White получается в результате использования оптического бесцветного стекла. Учтите, что при сравнении двух плиток разной длины количество света, проходящего через плитки, может повлиять на их цвет.

Данный эффект возникает в результате преломления лучей, призматического эффекта или хроматической аберрации. Во избежание данного эффекта, а также других эффектов затенения рекомендуется по возможности заполнять все пустоты на поверхности, выкладываемой плиткой.

Стекло следует резать подходящим электрическим плиткорезом с ре�цом для резки стекла, а неровные края необходимо отшлифовать соответствующим напильником. ВАЖНО: Плитку Splashbacks НЕЛЬЗЯ резать.

ПЛИТКА SPLASHBACKS

Будьте осторожны при обращении с плиткой Splashbacks до и во время ее укладки. Плитка Original Style Glassworks Splashbacks прошла испытания на соответствие британскому стандарту BS EN12150. Данная плитка изготовлена из закаленного (упрочненного) стекла, которое является разновидностью защитного стекла. Меры предосторожности при работе с закаленным стеклом такие же, как и при работе с отожженным (обычным) стеклом. В случае неаккуратного обращения или неправильной установки возможно повреждение краев; также возможно повреждение стекла впоследствии, при оказании механического воздействия на закаленное стекло с поврежденными краями, как, например, при установке. В результате резка, удар или падение приводит к немедленному полному разбиванию данного материала. Ни при каких условиях НЕ пытайтесь резать или сверлить плитку Splashback, поскольку это приведет к ее разбиванию. Пройдите по ссылке www.originalstyle.com/guides. Другую стеклянную плитку, в том числе бортики, можно резать. Рекомендуемый плиткорез: Rubi DW250N с ре�цом CPC2. Плитку также можно подгонять по размеру и резать плиткорезом Rubi TR с 18-миллиметровым роликовым ре�цом. При резке стекла необходимо помнить о соответствующих мерах предосторожности. Ознакомьтесь с нашим Руководством по укладке, доступным по ссылке: www.originalstyle.com/guides.

MIRROR FACET ПЛИТКА

Mirror Facet плитка (страницы 62-65) могут иметь острые края. Будьте внимательны при обращении и установке.

ВОЗДЕЙСТВИЕ ТЕПЛОМ

Всю плитку Glassworks, включая Splashbacks, необходимо укладывать не менее чем в 3см от любых источников тепла, которые включают среди прочего любые трубы с горячей водой, замурованные в стенах, и источники теплового излучения, такие как плиты, подогреваемые полотенцесушители и радиаторы. Не рекомендуется устанавливать стеклянную плитку рядом с источниками огня. Не допускайте прямого контакта горячей посуды со стеклянной плиткой Splashbacks.

При фиксации стеклянных плиток во влажных помещениях стены должны быть полностью гидроизолированы перед инсталляцией.

Мы не рекомендуем использовать стеклянные полосы для инсталляции на участках, подлежащих движению, то есть на деревянных стенах, поскольку подложка может привести к их разрушению.

МЕСТА, ПОДХОДЯЩИЕ ДЛЯ ИСПОЛЬЗОВАНИЯ ПЛИТКИ

Большинство Glassworks и Splashbacks продуктов подходит для внутренних стен как на влажных, так и на сухих участках, в жилых и коммерческих помещениях - см. Символы пригодности для отдельных продуктов.

Данная плитка не подходит для использования:

- как столешницы, поскольку она подвержена царапинам
- для полов
- для установки снаружи
- для установки в погруженных условиях, таких как бассейны или аквариумы
- для установки на поверхностях, подверженных смещению, таких как дерево или стекловолокно
- для каминных ниш и вблизи печ

Если они установлены под прямым солнечным светом, плитка может обесцветиться.

УКЛАДКА, КЛЕЯЩИЕ ВЕЩЕСТВА, ЗАТИРКИ, ЧИСТКА И УХОД

ЗАТИРКА

Всегда допускайте 2-3-миллиметровый зазор.

Стеклянные плитки НИКОГДА не должны стыкаться друг с другом, поскольку они могут либо расколоться, либо откальваться.

Прежде чем начинать укладку плитки, ознакомьтесь с Руководством по укладке, которое можно скачать по ссылке www.originalstyle.com/guides. Компания Original Style не несет ответственности за любые дефекты уже уложенной плитки.

ДРУГАЯ ПРОДУКЦИЯ КОМПАНИИ ORIGINAL STYLE

В данной брошюре представлена также другая продукция компании Original Style, такая как мозаичная, керамическая, фарфоровая и каменная плитка. На данную продукцию распространяются соответствующие требования по укладке. При укладке такой продукции обязательно ознакомьтесь с соответствующей брошюрой Original Style и Руководством по инсталляции в www.originalstyle.com для этих продуктов перед установкой.

Фотографии

С учетом освещения в студии и типографической краски, цвет плитки на фотографиях, представленных в данной брошюре, может незначительно отличаться от фактического цвета плитки. Рекомендуется потребовать образец плитки у поставщика Original Style.

Ограничение ответственности

Компания Original Style не несет ответственности за дефекты при установке ее продукции. При возникновении претензий относительно качества плитки, ответственность компании Original Style в установленных законом случаях ограничена либо заменой товара, либо возмещением его стоимости, и не распространяется на возмещение косвенных убытков. О претензиях необходимо сообщать в течение 7 рабочих дней после получения плитки. Плитку следует проверить до ее установки. После установки плитки претензии не принимаются. Просьба обратить внимание, что установка плитки означает отсутствие претензий к ее качеству, цвету, размерам, текстуре и оттенкам. Компания Original Style гарантирует, что плитка соответствует ее описанию и пригодна для использования в надлежащих целях. Компания Original Style не предоставляет ни прямых, ни косвенных гарантий соответствия или пригодности товара для конкретных видов установки. Мы не обеспечиваем ни прямые, ни косвенные гарантии износостойчивости и исправности. Просьба отметить, что использование определенных чистящих средств на кислотной основе способно привести к возникновению химической реакции и изменению свойств плитки.



SAND + FOG
POMEGRANATE
NOIR

58 BALANCING
BODY WASH
A Soothing Wellbeing blend of Green Mandarin,
Candied Citrus, Cardamom, Ylang Ylang,
and Ylang Ylang
SOOTHING WELLBEING
A soothing, soothing blend infused with aromatic
and nourishing natural botanicals to refresh
and uplift the spirit.
100ml / 3.3 fl.oz



ACKNOWLEDGEMENTS

We are very grateful to the following companies for their assistance with the photographic settings:

Amos Lighting	www.amoslighting.co.uk
Anthropologie	www.anthropologie.com/en-gb
Atkin & Thyme	www.atkinandthyme.co.uk
Audenza	www.audenza.com
Bathroom Village	www.bathroomvillage.com
Cox & Cox	www.coxandcox.co.uk
Darts Farm	www.dartsfarm.co.uk
Debenhams	www.debenhams.co.uk
Finnish Design Shop	www.finnishdesignshop.com
Furniture Village	www.furniturevillage.co.uk
Grace & Glory	www.graceandgloryhome.co.uk
John Lewis	www.johnlewis.com
Joseph Joseph	www.josephjoseph.com
Karen Millen	www.karenmillen.com
Laura Ashley	www.lauraahsley.com
Noble Isle	www.nobleisle.com
Oliver Bonas	www.oliverbonas.com
Orange Tree	www.theorangetree.co.uk
Plumb Centre	www.plumbcenter.co.uk
Printer and Tailor	www.printerandtailor.com
Reflections Bathrooms	01392 204529
Rose & Grey	www.roseandgrey.co.uk
Samuel Heath	www.samuel-heath.co.uk
Soak	www.soak.com
Urbanara	www.urbanara.co.uk
Victorian Plumbing	www.victorianplumbing.co.uk
Vogue UK	www.vogue-uk.com
West Elm	www.westelm.co.uk
William Garvey	www.williamgarvey.co.uk





Tileworks

Contemporary ceramic and porcelain tiles in a range of colours and shapes



Earthworks

Natural stone for walls and floors



Odyssey

Patterned wall and floor tiles inspired by journeys of discovery



Mosaics

Glorious mosaics in every material and style imaginable

GENERAL ENQUIRIES

Tel: +44 (0)1392 473004
Fax: +44 (0)1392 473014

UK SALES

Tel: +44 (0)1392 473000
Fax: +44 (0)1392 473010

USA SALES

Tel: 508 507 6228
Fax: 1-866 881 6609 (toll free)

EXPORT SALES

Tel: +44 (0)1392 473001
Fax: +44 (0)1392 473011

Email: info@originalstyle.com

Website: www.originalstyle.com

The 'Original Style' logo is a registered trade mark of Original Style Ltd.
Original Style Limited is registered in England number 3018117. Registered
Office: Falcon Road, Sowton Industrial Estate, Exeter, Devon EX2 7LF, England

Your Original Style stockist

£3.00 €4.00 \$4.00

GW-GLBROCH4/08/18

Printed using Vegetable inks

© Copyright Original Style Ltd 2018

